

ICPDP 2014, New Delhi, India

# 25 Years of Dust Acoustic Wave Physics

*Bob Merlino*

*University of Iowa*

## Collaborators

*A. Barkan, N. D'Angelo, R. Fisher, J. Heinrich,  
S-H. Kim, J. Meyer, M. Rosenberg, E. Thomas,  
C. Thompson, V. Nosenko*

Work supported by ONR, NSF, and DOE

# OUTLINE

- Dust acoustic waves – history
- Basic theory of the DAW
- DAW experiments
  - Non-linear DAW
  - DAW growth rate measurements
  - DA shock waves
- Importance of DAW
- Dust agglomeration due to NL DAWs
- Final remarks

# Dust Acoustic Waves

- 2014: 25<sup>th</sup> year since the First Capri Workshop on Dusty Plasmas where the dust acoustic wave was first discussed by Padma Shukla.
- The detailed calculation of the linear *and* nonlinear dispersion properties of this dust mode was published a year later (Rao, Shukla, and Yu, Planet. Space Sci. 38, 543, 1990).
- *Google*: Dusty plasma: 1,360,000, DAW: 351,000
- *Web of Science*: DAW 1638 papers, about 5.5/yr

# Web of Science Citations: Rao, Shukla, and Yu

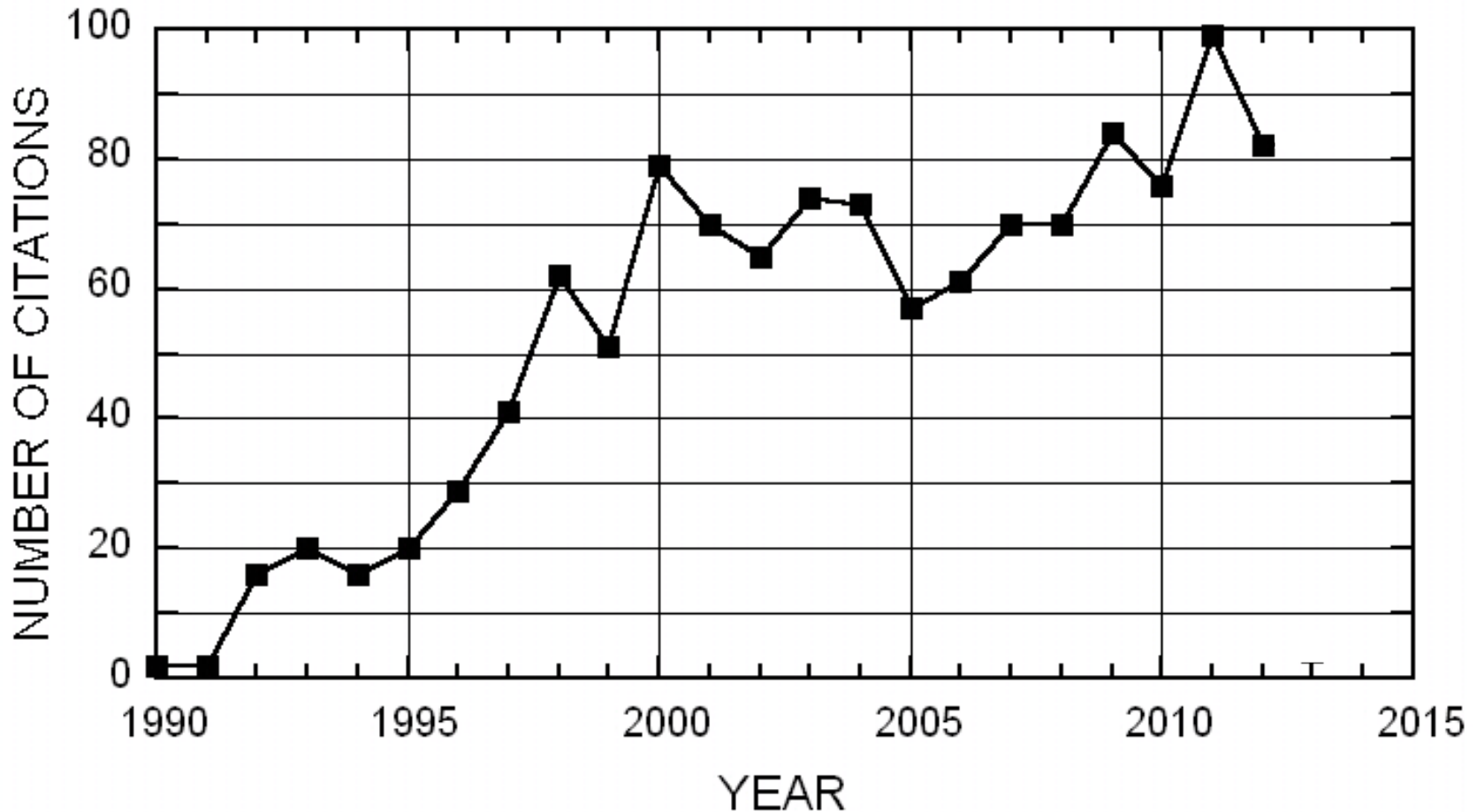

# First Capri Workshop on Dusty Plasmas

May 28 – June 2, 1989

T. Aansen	M. Horanyi	C. Nairn
J. E. Allen	I. T. Iakubov	C. Nappi*
B. Bingham*	J. G. Laframboise	W. Philipp
U. de Angelis*	F. Melandsø	P. K. Shukla
C. Goertz	N. Meyer-Vernet	V. Tsytovich*
O. Havnes	G. Morfill*	* <b>Organizer</b>

- Umberto de Angelis persuaded Padma Shukla to attend the workshop, since Padma was reluctant, arguing that: *“I know nothing about dusty plasmas.”*
- Umberto told him: *“neither do we, we meet to start the field.”*

# Initial discussions on the DAW

- Toward the end of the Capri workshop, Padma discussed with Umberto the possibility that dusty plasmas might support very low frequency waves that involved the dynamics of the heavy charged dust particles.
- The question was how to model the dust particles. Padma suggested that the dusty plasma could be analyzed as a multicomponent plasma, with the dust treated as an ordinary fluid component.
- Due to the large disparity of the masses, Padma argued that the electrons and ions could be treated as massless fluids that obeyed the Boltzmann distribution.
- The details were worked out in Bochum (RSY, PSS, 1990)

# Dust acoustic waves: fluid theory (1)

- Continuity eqn:  $\frac{\partial n_d}{\partial t} + n_{do} \frac{\partial u_d}{\partial x} = 0$
- Momentum eqn:  $m_d n_{do} \frac{\partial u_d}{\partial t} + kT_d \frac{\partial n_d}{\partial x} - eZ_d n_{do} \frac{\partial \phi}{\partial x} = 0$

- $m_d \gg m_{e,l} \rightarrow$  Boltzmann electrons and ions:

$$kT_e \frac{\partial n_e}{\partial x} - en_{eo} \frac{\partial \phi}{\partial x} = 0; \quad kT_+ \frac{\partial n_+}{\partial x} + en_{+o} \frac{\partial \phi}{\partial x} = 0$$

- Poisson's eqn:  $\nabla^2 \phi = -(e/\epsilon_o)(n_+ - n_e - Zn_d)$
- Quasineutrality condition for  $K\lambda_D \ll 1$ :  $n_+ = n_e + Z_d n_d$
- All first order quantities:  $\propto \exp[i(Kx - \omega t)]$

## Dust acoustic waves: fluid theory (2)

Combining the dust momentum equation with the ion and electron momentum equations we see that (*for the case of cold dust,  $T_d = 0$* ).

$$m_d n_{d0} \frac{\partial u_d}{\partial x} = - \frac{\partial P}{\partial x}$$

Where  $P = P_e + P_+$  is the total plasma pressure

In the dust acoustic wave the inertia is provided by the massive dust particles and the electrons and ions provide the restoring force



# Dust acoustic dispersion relationship

*acoustic modes (long wavelength)  $\omega = K C_{DA}$*

$$C_{DA} = \left( \frac{k_B T_d}{m_d} + \frac{\alpha Z_d^2 k_B T_i}{m_d \left[ 1 + (T_i/T_e)(1 - \alpha Z_d) \right]} \right)^{1/2} \quad \alpha = n_{do} / n_{io}$$

*finite  $K\lambda_D$  effects:*

$$\omega = \frac{K}{\sqrt{1 + K^2 \lambda_D^2}} C_{DA}$$

$$\lambda_D^{-2} = \lambda_{De}^{-2} + \lambda_{Di}^{-2}$$

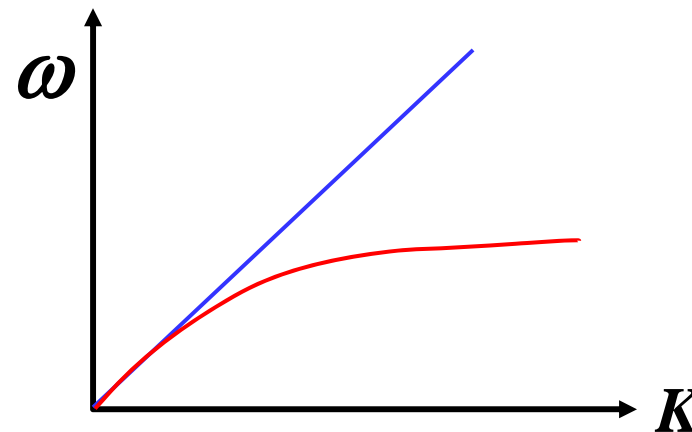

# Further theoretical developments

- 1993: Rosenberg using Vlasov theory showing instability for ion drifts  $u_0 > \text{DA phase speed } v_{ph}$  (Excitation of DA instability)
- 1992, 93: Melandso; Varma, Shukla and Krishan account for effects of dust charge fluctuations – a new collisionless damping mechanism
- 1995, 99: Winske et al., perform 1D PIC simulation of DAI showing saturation by ion trapping
- 1996: Collisional effects on ion-dust streaming instability considered by D'Angelo and Merlino (fluid) and Rosenberg (Vlasov).
- 2000-05: Fortov et al.: DAI in DC glow discharges- effects of dust charge perturbations, external charge dependent forces, ion drifts. Periodic variations of the charge-dependent forces can lead to parametric amplification of DAW leading to instability.

# Effects of Strong Coupling on DAW

- Dusty plasmas can exist in the strongly coupled state where  $\Gamma (= Q^2/a kT_d) > 1$ .
- These effects may be manifested in the collective behavior of dust waves  $\rightarrow$  DAW exps. can provide insight into physics of strongly coupled plasmas.
- Strong coupling effects have been incorporated in the dispersion relation for DAWs
  - Wang and Bhattacharjee (1997)
  - Kaw and Sen (1998)
  - Rosenberg et al. (2014)  $\rightarrow$  strong coupling effects enhance instability

# Dust acoustic wave excitation

Ion-dust streaming instability: Fluid theory with zero-order ion drift and neutral collisions

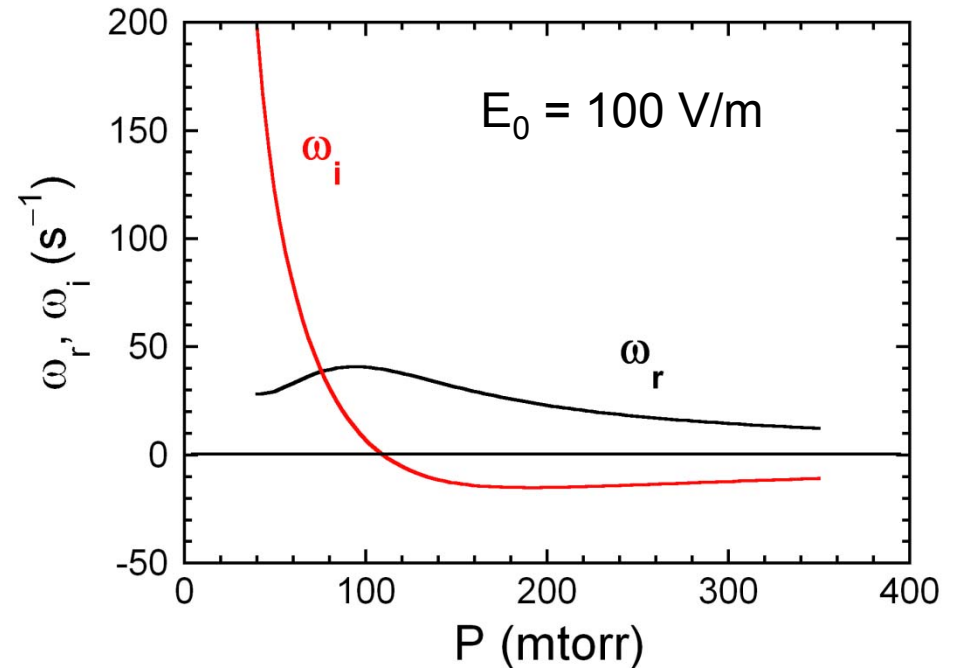
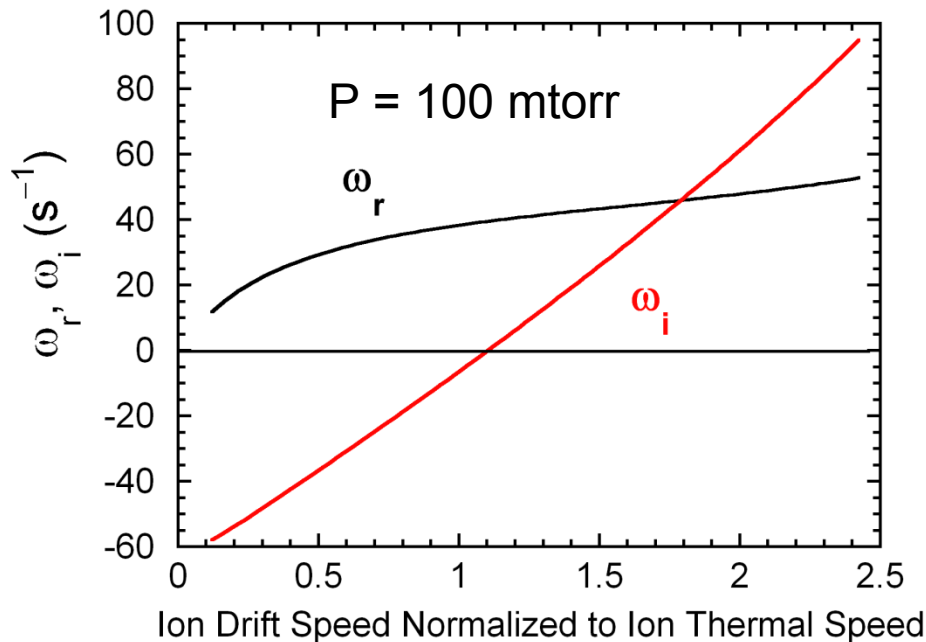

Parameters

$$\left\{ \begin{array}{l} r_d = 0.5 \mu\text{m}, \quad Z_d = 2000, \quad n_d \sim 10^{11} \text{m}^{-3} \\ A_i = 40, \quad n_i \sim 10^{15} \text{m}^{-3}, \quad T_e = 2 \text{ eV} \\ K = 1.26 \text{ mm}^{-1}, \quad (\lambda = 5 \text{ mm}) \end{array} \right.$$

# DAWs in Discharge Plasmas

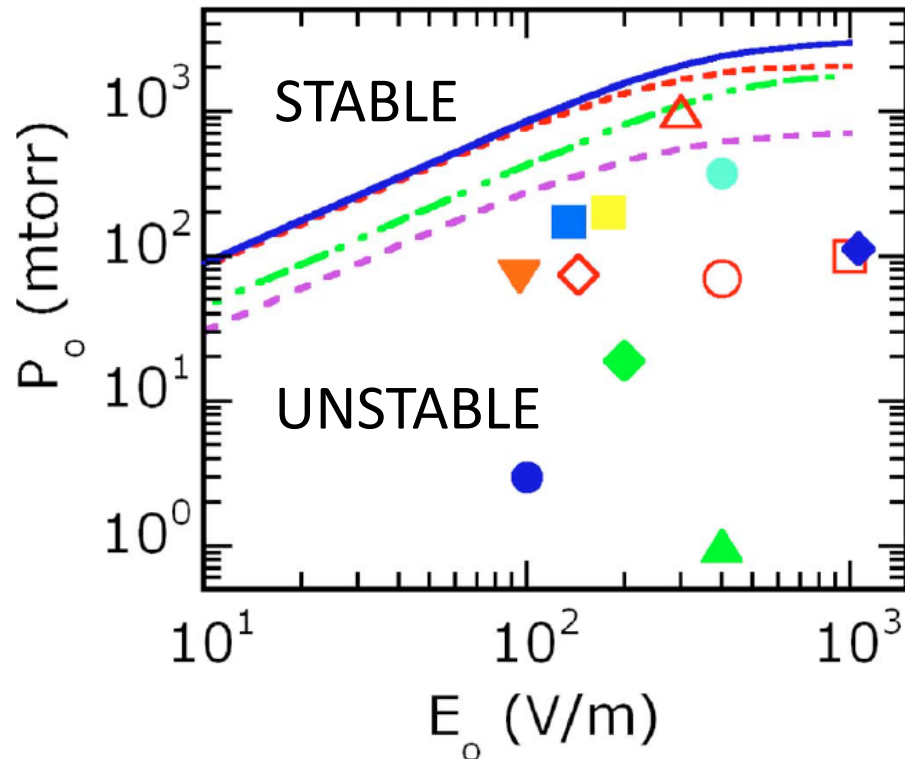

- Dust acoustic waves are ubiquitous in discharge plasmas with suspended dust
- Using fluid theory of ion-dust streaming instability in a collisional plasma, a stability plot in the  $P_0 - E_0$  plane is shown (curves)
- The individual points represent various experiments where DAWs were observed.
- Typical ion drifts are sufficient to produce DAWs

# “Early” experiments on DAWs

- Chu, Du, and I (J. Phys. D: Appl. Phys. 27, 295, 1994) in an RF magnetron plasma grew 1 mm dust particles using  $\text{SiH}_4/\text{O}_2/\text{Ar}$  gas mixtures.
  - Fluctuations in plasma emission and scattered laser light from dust density (*which were out of phase*);  $f \approx 12$  Hz,  $\lambda \approx 0.5$  cm, observed.
  - If the neutral pressure was increased, suppressing the fluctuations, a Coulomb solid was formed.
- D’Angelo (J. Phys. D: Appl. Phys. 28, 1009, 1995) interpreted these fluctuations as DAWs.
- Pieper and Goree (PRL 77, 3137, 1996). The dispersion relation for DAW in the strong-coupling regime measured. Agreement found with dispersion relation derived from fluid theory (Rao, Shukla, Yu, with d-n collisions).
- Prabhakara & Tanna, IPR (PoP 3, 3176, 1996) Uses a hot cathode discharge; measured DAW spectrum

# DA wave observations at low $\omega$

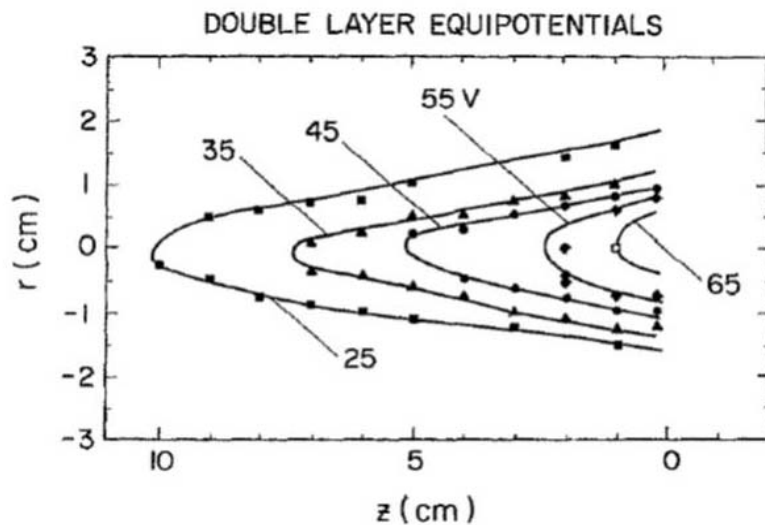
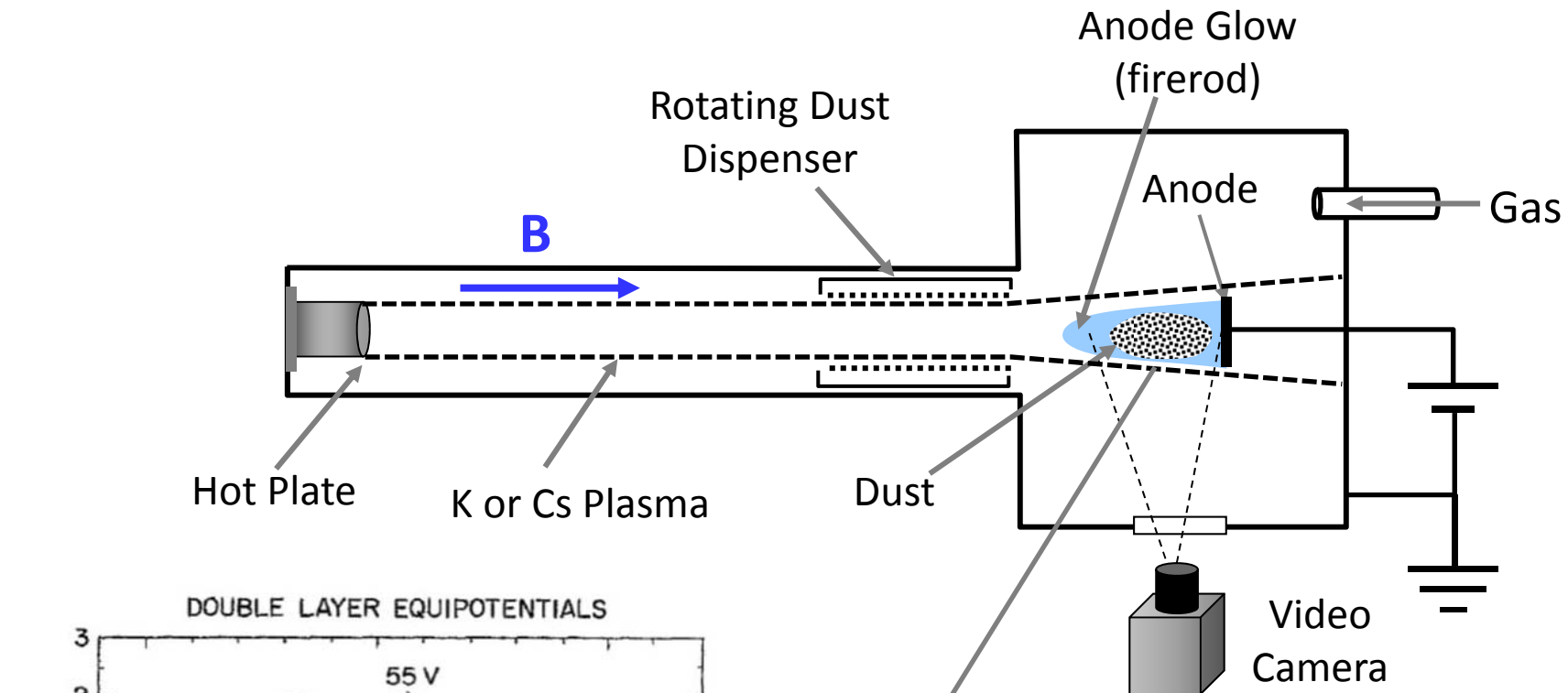

Dust confined in an anode double layer (firerod) formed in the diverging field region of a Q machine plasma.

# Observation of the DAW

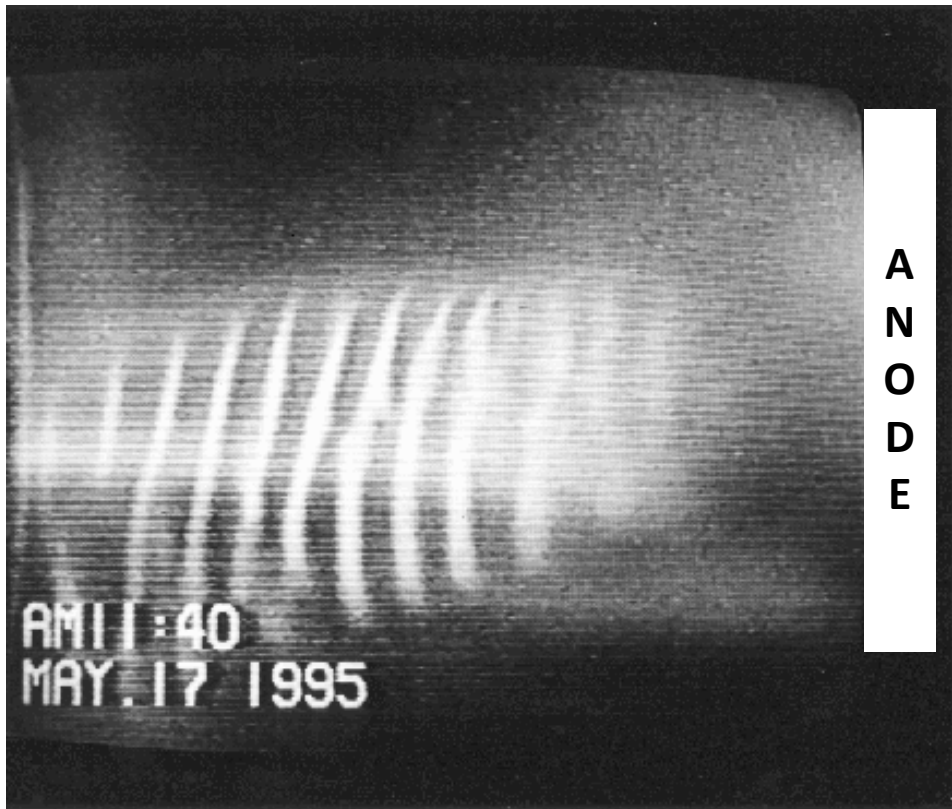

- Plasma  
 $K^+/e^-$ ,  $B = 0.3 \text{ T}$
- Dust  
aluminum silicate powder  
average size  $\sim 5 \mu\text{m}$   
 $Z \approx 10^4$
- Anode glow plasma  
Neutral gas ( $\text{N}_2$ )  
Pressure = 70 mtorr  
Anode voltage = 200 V
- Dust acoustic waves  
Wavelength = 0.6 cm  
Frequency = 15 Hz  
Phase velocity = 9 cm/s



# Measurement of the dispersion relation

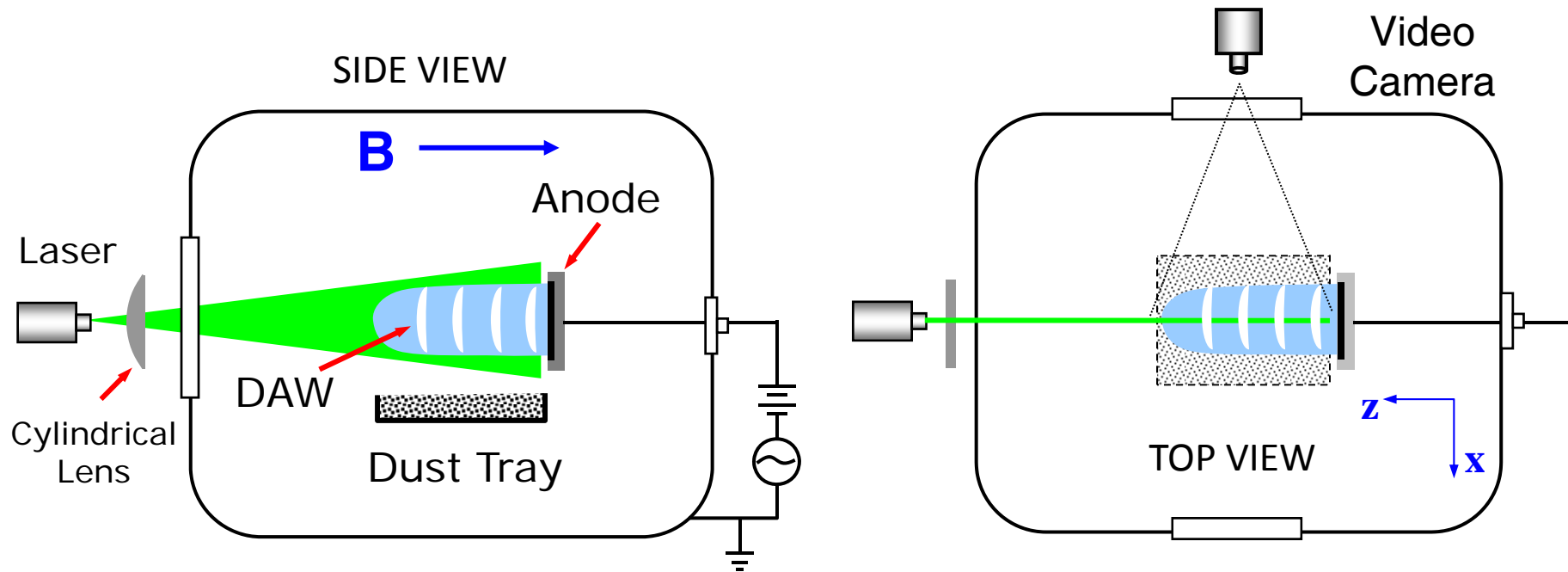

- DC glow discharge in argon:  $P = 100$  mTorr (13 Pa)
- $T_e \approx 2-4$  eV,  $T_i \approx 0.03$  eV  $n_e \sim n_i \sim 10^{15} \text{ m}^{-3}$
- Dust: aluminum silicate powder
- Size  $\sim 5 \mu\text{m}$   $Z \sim 1800$
- Wave frequency synchronized by applying AC signal to anode.

# Results

## Dust Acoustic Waves

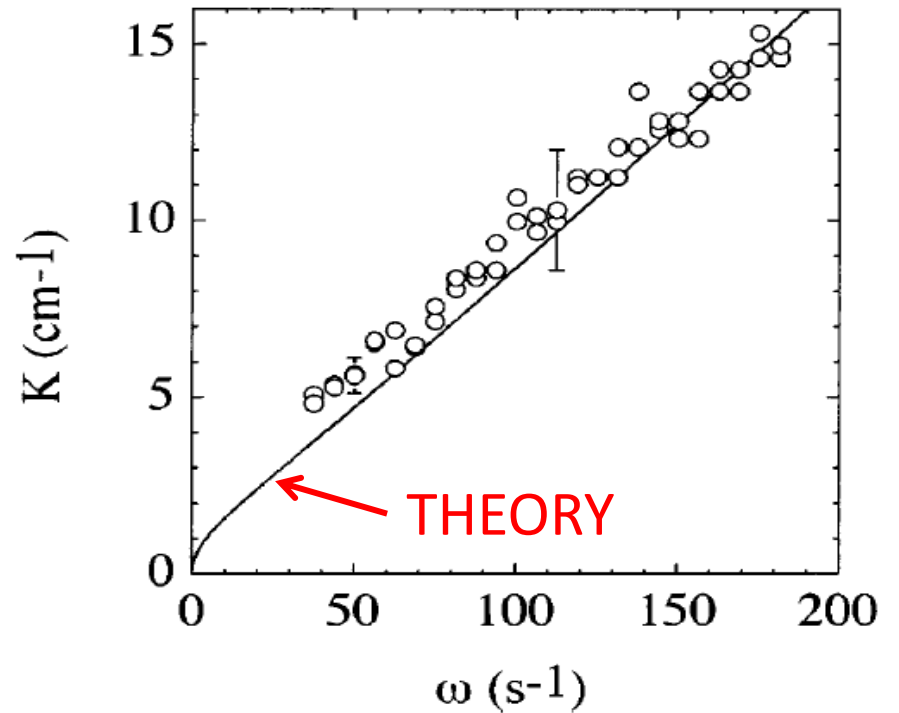

The dispersion relation, including the effects of dust-neutral collisions with frequency  $\beta$ :

$$\omega(\omega + i\beta) = K^2 C_{DA}^2$$

# Dust acoustic wave experiments (1)

- Fortov et al. (IHED)
  - (1999) Dust trapped in a standing striation of DC discharge. Oscillations appeared when a sufficient dust density was trapped; disappeared at high pressure
  - (2000) Experiment and theory showing the effect of dust charge variation in the presence of external charge-dependent forces with ion drift produces DAI.
  - (2002) DAI in inductive rf gas discharge. Showed that variable dust charge facilitates instability but is not necessary
- Fortov (IHED) / Morfill (MPE) (microgravity conditions)
  - (2003) First experimental study of low-frequency dust waves on the ISS (PKE-Nefedov Lab). Waves excited by low-frequency modulation to the rf electrode. Waves observed in the small grain cloud, *but not in high  $\Gamma$  large grain cloud.*
  - (2004) Exp. on PKE-Nefedov device except *at factor of 2 lower pressure.* Waves observed in both small and large grain clouds, as well as appearance of a specific waveguide.

- J. Goree (Univ. Iowa)
  - (2010).— Spatial growth of DAWs observed and critical pressure for excitation found.
  - (2011).— Growth of DDW observed as waves propagate. Second and third harmonics observed.
- Lin I group (National Central Univ., RoC)
  - (2008) Studied particle-wave interaction in nonlinear self-excited DAW; nonlinear particle motion, trapping and heating. Nonlinear particle motion sustains waves. Observed transition from liquid to gas state as wave amplitude increases.
  - (2009) Detailed observations of particle micro-dynamics and wave breaking; onset of de-phased dust oscillations in DAWs and positive Lyapunov exponent; strong wave heating occurs after wave breaking

- Institute for Plasma Research (IPR)
  - Prabhakara & Tanna (1996) Observed self-excited DAW in a hot cathode discharge dusty plasma; measured DAW spectrum
  - Pramanik *et al.* (2003) Observed the transition from coherent DAW at high pressure to turbulent DAW at low pressure.
  - Bandyopadhyay *et al.* (2007) Measured effects of strong coupling on DAW dispersion relation.
- A. Piel Christain-Albrechts Univ.
  - (2006).— Presented detailed model of dust confinement in anodic discharge; measured DAW dispersion relation, compared with kinetic theory
  - (2009).— Synchronization of dust density waves (DDW) due to modulation of ion density.

- Ed Thomas, Jr. Auburn Univ. (DC glow discharge)
  - (2006) Applied stereo-PIV technique to observe spatial growth of DAW. Measured  $k_i$  as a function of neutral pressure.
  - (2007) DAW driven at high frequencies
  - (2008) Obtained DAW dispersion relation; studied effect of finite  $T_d$
- J. D. Williams, Wittenberg Univ. (DC glow discharge)
  - (2010) Coupling of self-excited DAW and DAW driven by current modulation
  - (2013) Spatial evolution of the DAW
  - (2014) Evolution of frequency clusters in DAW. Association of frequency variations with merging and splitting of DAW wavefronts

# Non-linear DAWs

- Typically DAWs reach very high amplitudes with non-sinusoidal waveforms, peaked crests and flat troughs
- This is due to the appearance of higher harmonics for high wave amplitudes. The harmonics are solutions to the higher-order wave equations.

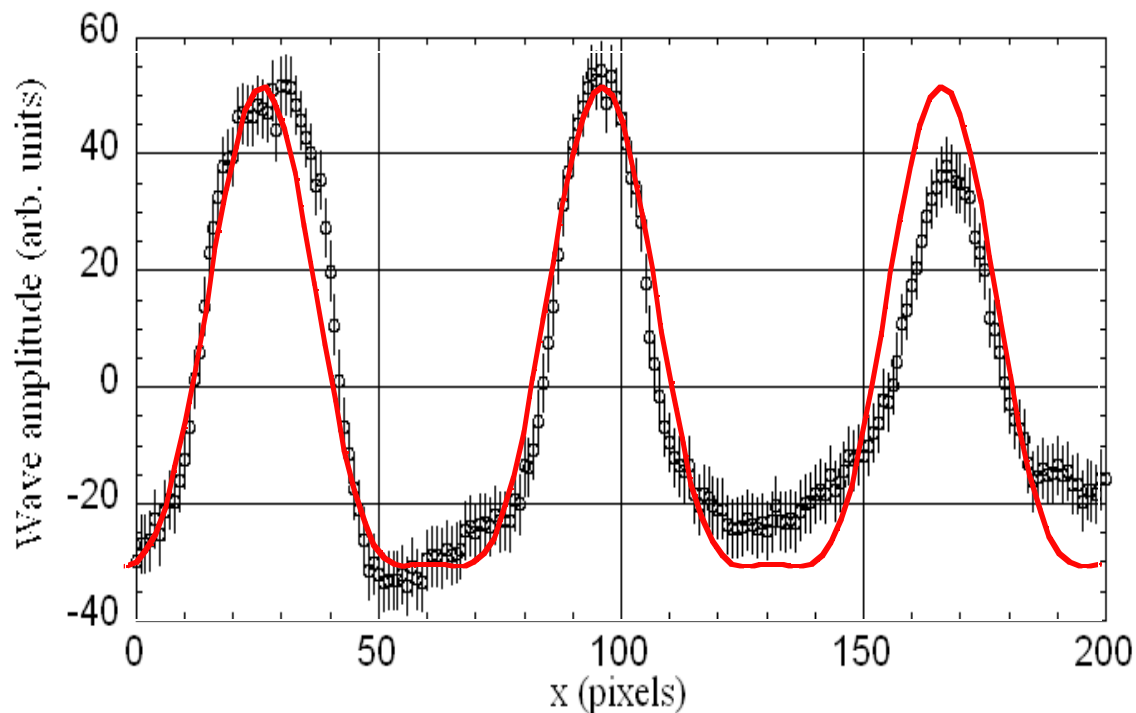

Second-order wave theory

$$\frac{\partial^2 n_{d2}}{\partial x^2} - \frac{1}{C_{da}^2} \frac{\partial^2 n_{d2}}{\partial t^2}$$

$$= A \frac{\partial^2 n_{d1}^2}{\partial x^2} + B \frac{\partial^2 n_{d1}^2}{\partial x \partial t}$$

$$\eta(x, 0) \sim \cos(Kx + \varphi)$$

$$+ \sigma \cos[2(Kx + \varphi)]$$

# DAWs excited in a drifting dust cloud: measurement of the growth rate

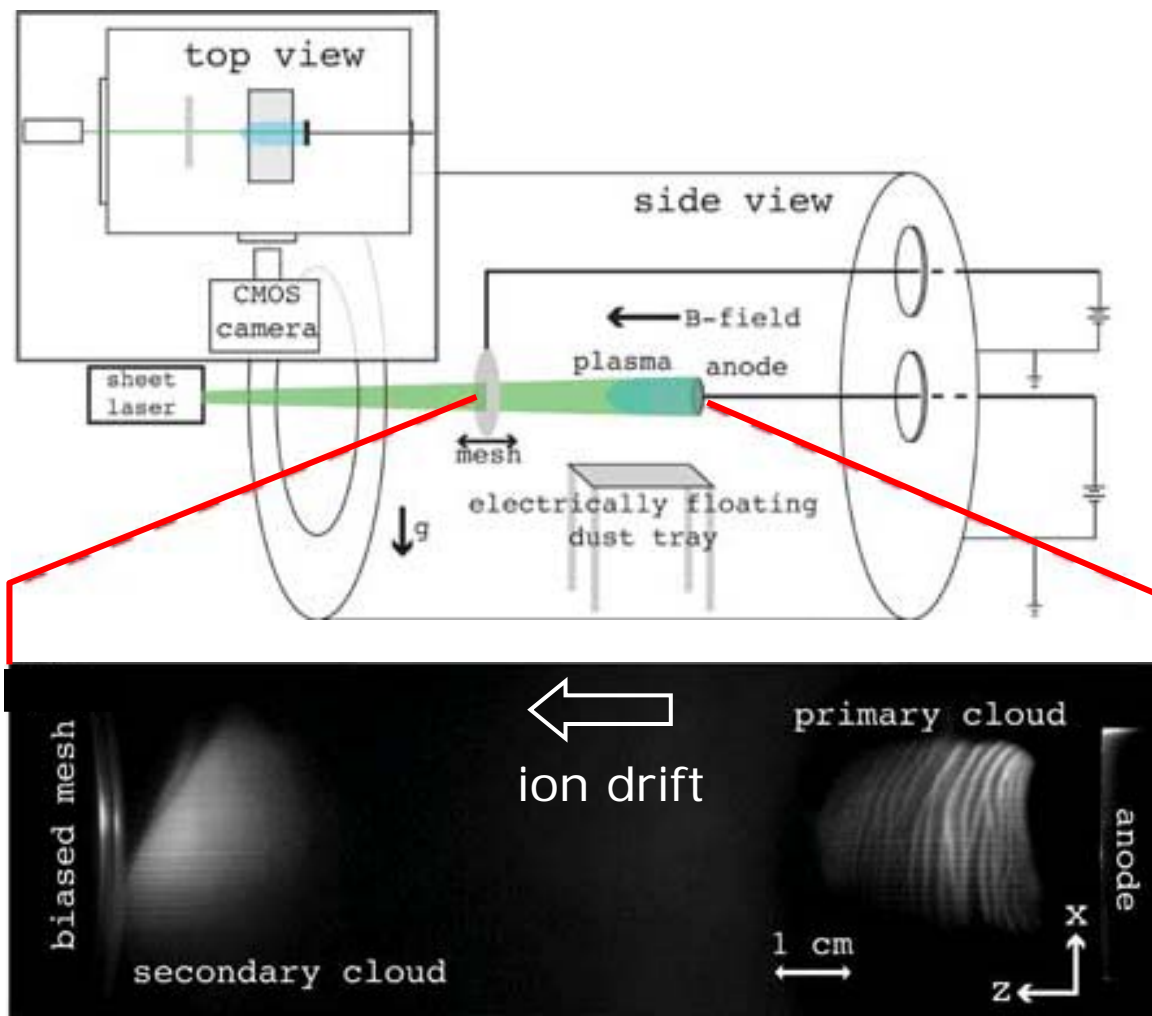

- A secondary dust suspension is trapped by a biased grid 15 cm from the anode.
- When the bias on the grid is switched off, the grid returns to its floating potential, and the secondary cloud is released.
- The secondary cloud begins drifting toward the anode.



# Drifting dust cloud and DAWs

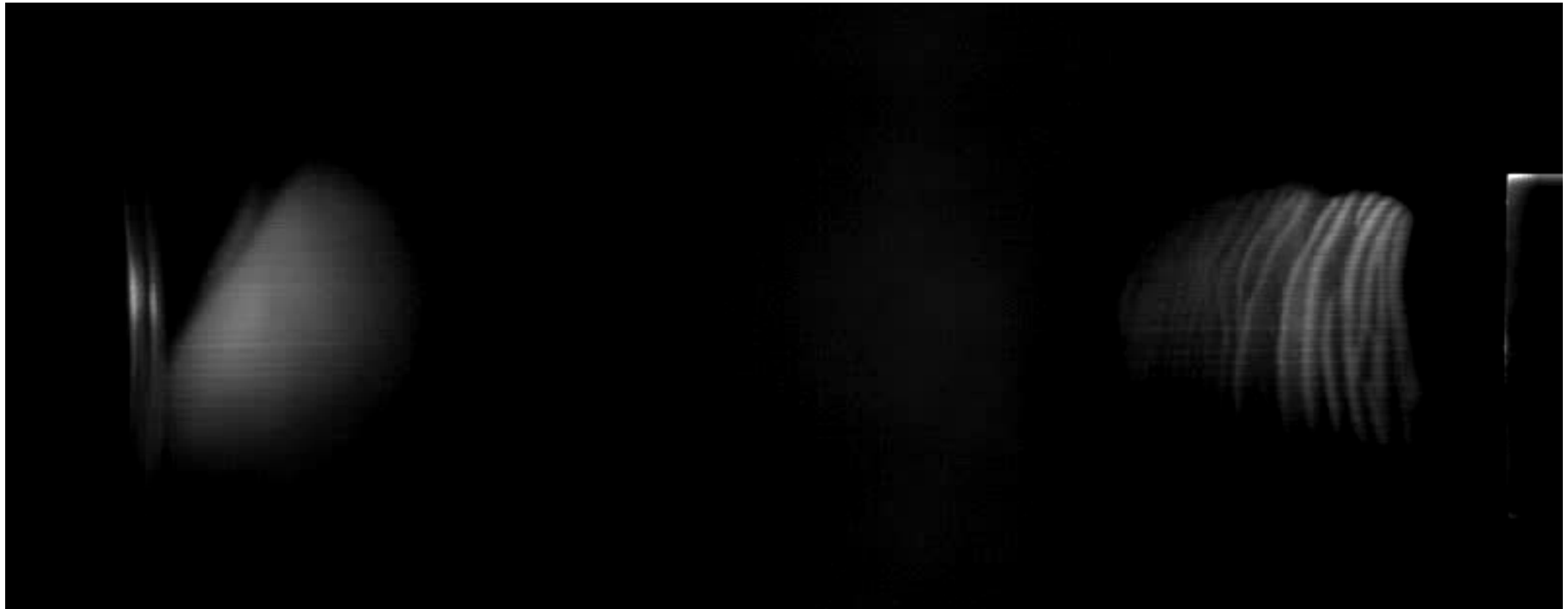

- When the center of cloud is about 10 cm from the anode, dust acoustic waves begin to be excited in the *quiescent* dust cloud.
- The DAWs begin being excited when they reach the point where the ion drift is sufficient to drive the ion-dust streaming instability

# Growth rate measurement

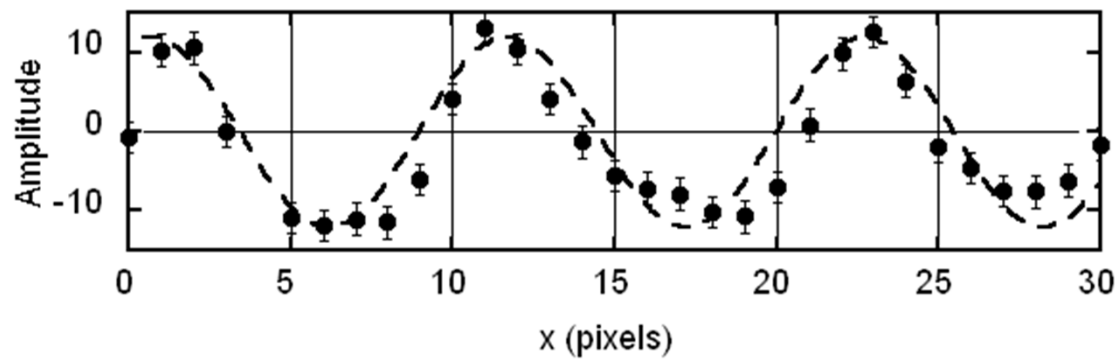
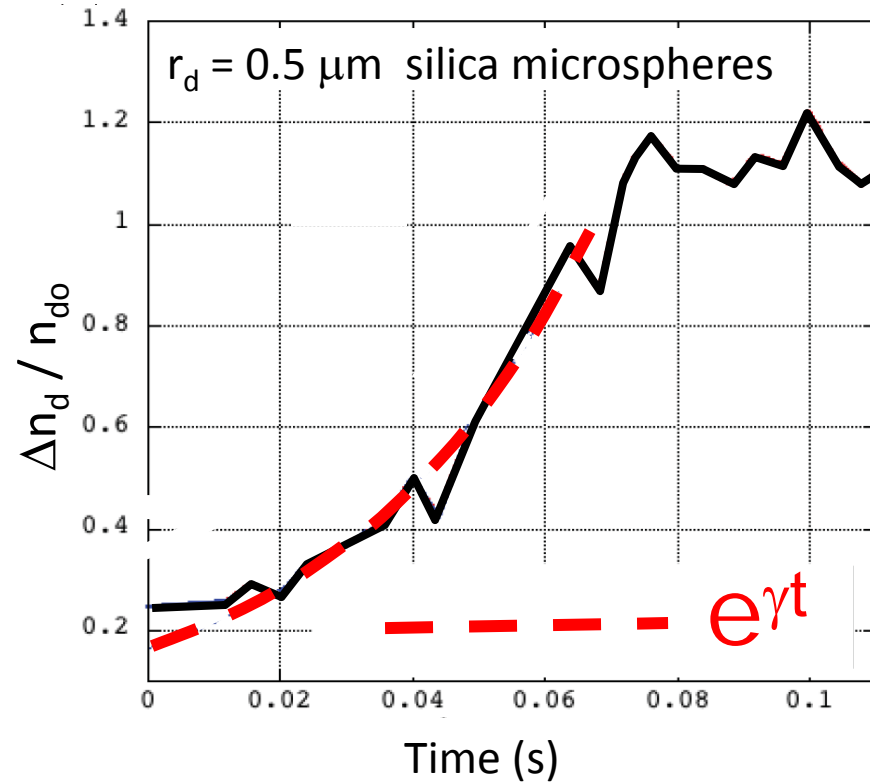
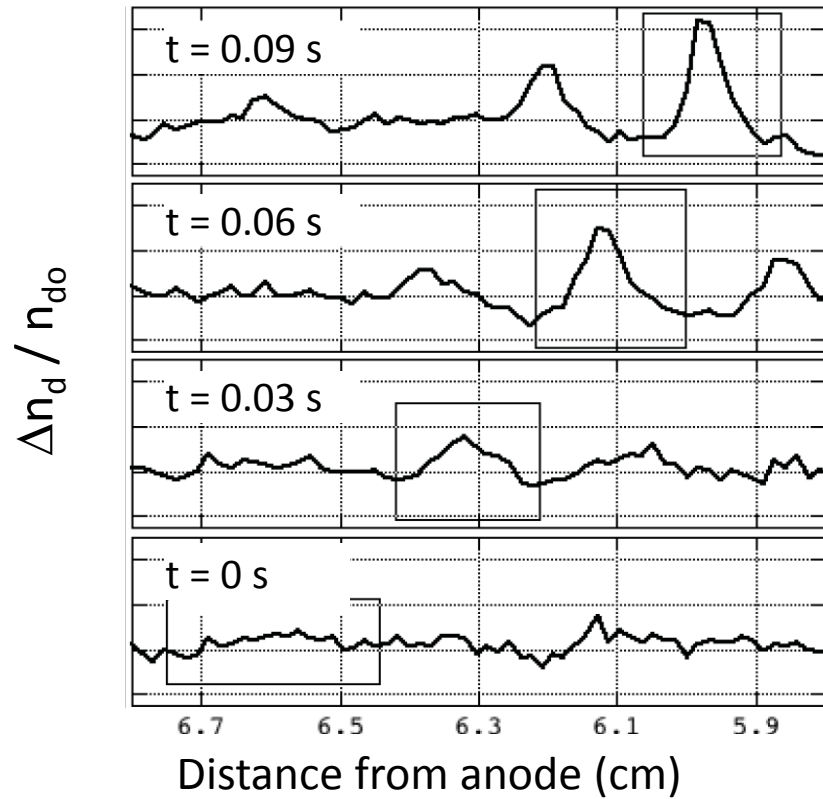

$$\frac{\Delta n_d}{\langle n_d \rangle} \approx 0.2$$

# Self-excited Dust Acoustic Shocks

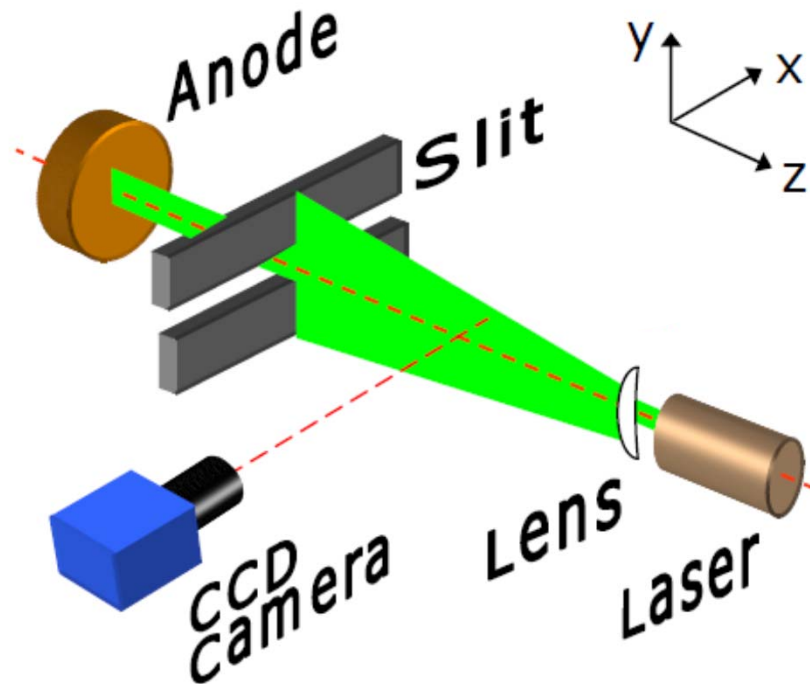

The experimental setup was modified by adding a slit in front of the anode

The slit produces a nozzle-like potential configuration that favors the formation of highly-compressed dust pulses

# DA Shock Experiment

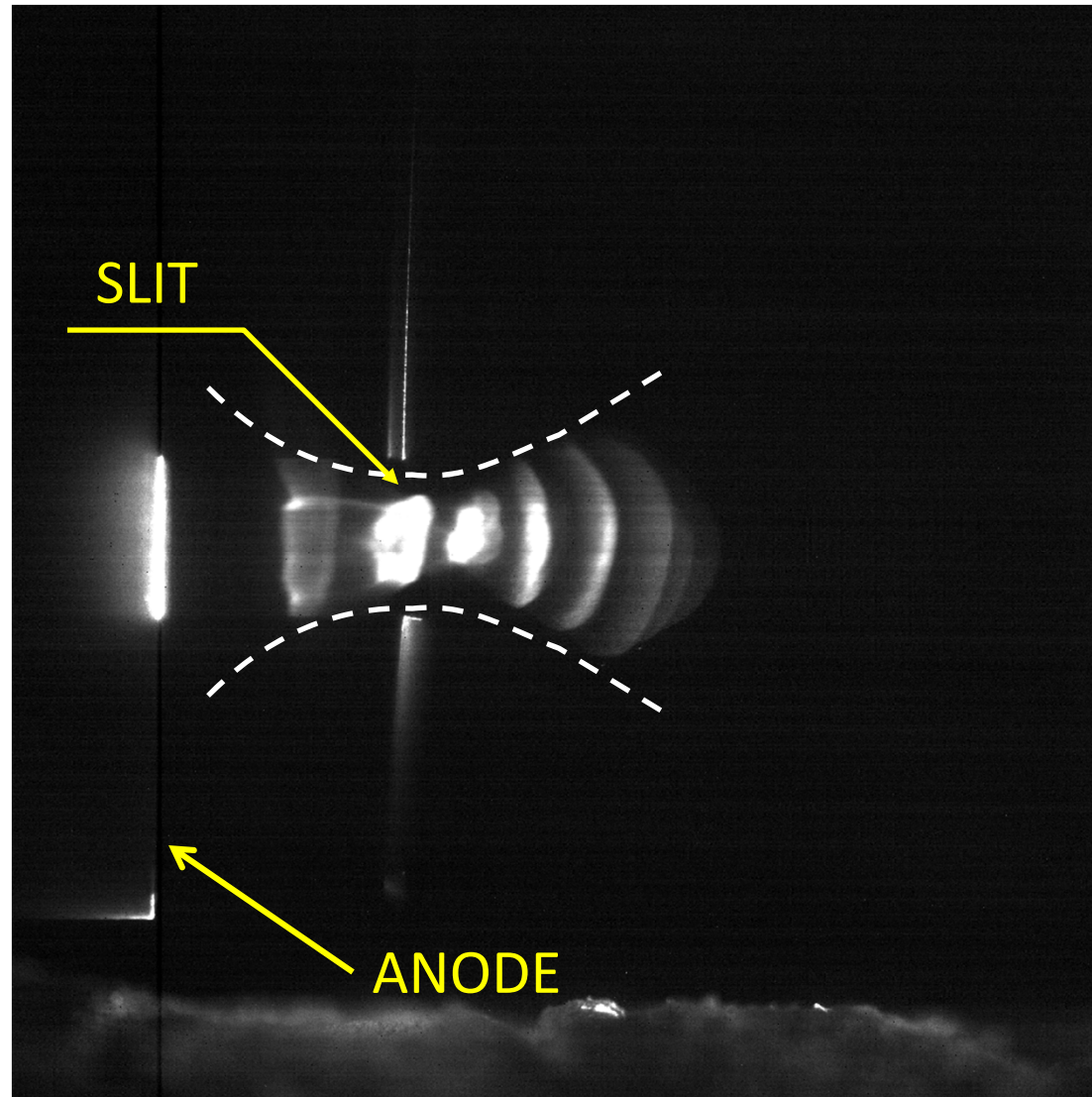

# Steepening of nonlinear DAW into Dust acoustic shocks

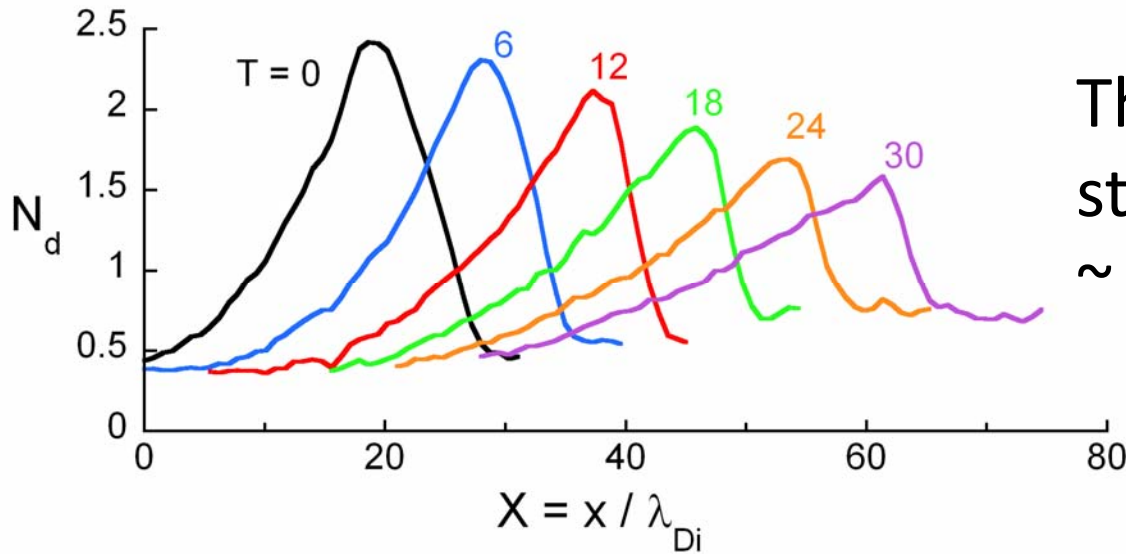

The thickness of the stationary shock is on  $\sim$  interparticle spacing.

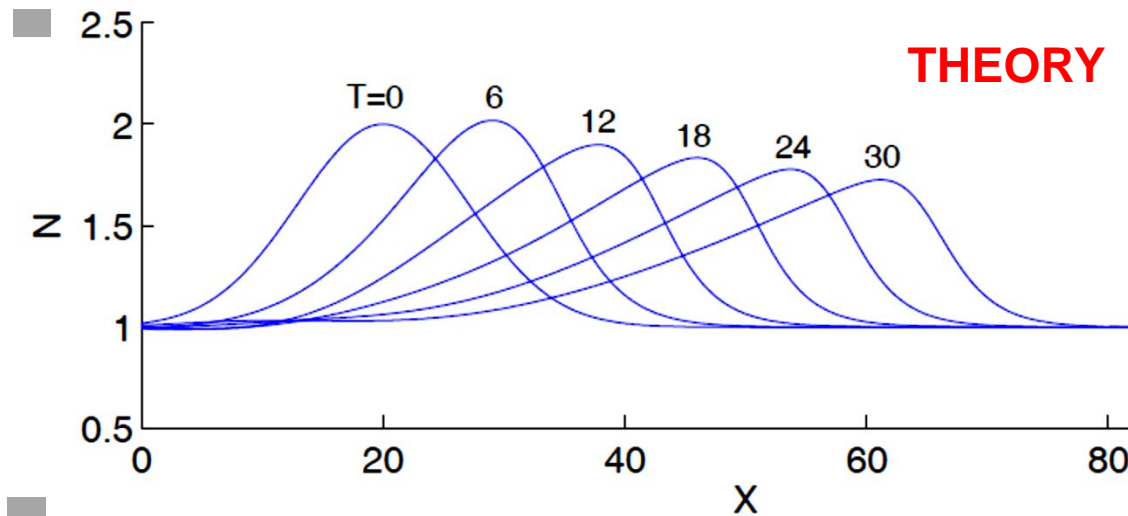

Eliasson  
& Shukla  
PRE 2012

# Shocks in Dusty Plasmas

- Li and Havnes (PRE 2001) – First theory
- Samsonov et al. (PRE 2003) – Used gas pulse to excite dust front in rf plasma on PKE-Nefedov. Front steepened into a shock. Shock width  $\sim$  interparticle spacing
- Fortov et al. (PRE 2005) – Excited dust density pulse in dust cloud trapped in positive column by applying a magnetic pulse with external coil. Density wave developed into a DA shock.
- Eliasson & Shukla (PRE 2004) – Obtained shock solutions to fully nonlinear DAW fluid equations. Initial Gaussian pulse steepened into shock. (PRE 2012) – Included effects of strong coupling, viscosity and polarization force.

# Importance of dust acoustic waves

- Basic plasma physics  
Linear and NL DAW can be studied at the single particle level. This is not possible with usual plasma waves
- Applications to natural phenomena
  - Dust plasmas in mesosphere
  - Fluctuations in planetary rings
  - Waves in cometary dusty plasmas
  - Dust environment of the moon – LADEE mission
- Astrophysics  
DAW / DA shocks may trigger agglomeration of charged dust → formation of larger objects

# Rosetta Mission (ESA)



- Rendezvous to comet *67P/Churyumov-Gerasimenko* in Nov. 2014; will escort comet around Sun to permit observations of the entire range of dusty plasma phenomena, from nucleus to fully developed comet tail, at high resolution
- According to Mendis & Horanyi (Rev. Geo. 2013), the high-resolution cameras on Rosetta **might be able to capture small scale structures of possible dust acoustic waves.**
- Arshad, Ehsan, Khan, & Mahmood (Phys. Plas. 2014) showed that DAI can be driven by solar wind streaming through comet tail.



# Dust agglomeration induced by dust density waves (1)

- Agglomeration of nanoparticles inhibited by dust charge as particles get to  $\sim 100$ s of microns.
- Agglomeration of micron-sized particles impossible due to strong Coulomb repulsion.
- Recent experiments indicate that agglomeration of micron-sized particles occurs in dusty plasmas with highly-nonlinear DAWs.
  - C.-R. Du et al., Phys. Plasmas 17, 113710, 2010.
  - S. Dap et al., Phys. Rev. Lett. 109, 245002, 2012.

(2)

- Du et al., showed that by triggering DAWs, microparticles could be accelerated sufficiently to overcome Coulomb repulsion.

- Dap et al., point out that this process is further enhanced by the fact that as particles get closer, their Debye spheres overlap, leading to a reduction in their charge. They directly observed the collision of 2 particles and the resulting agglomeration.

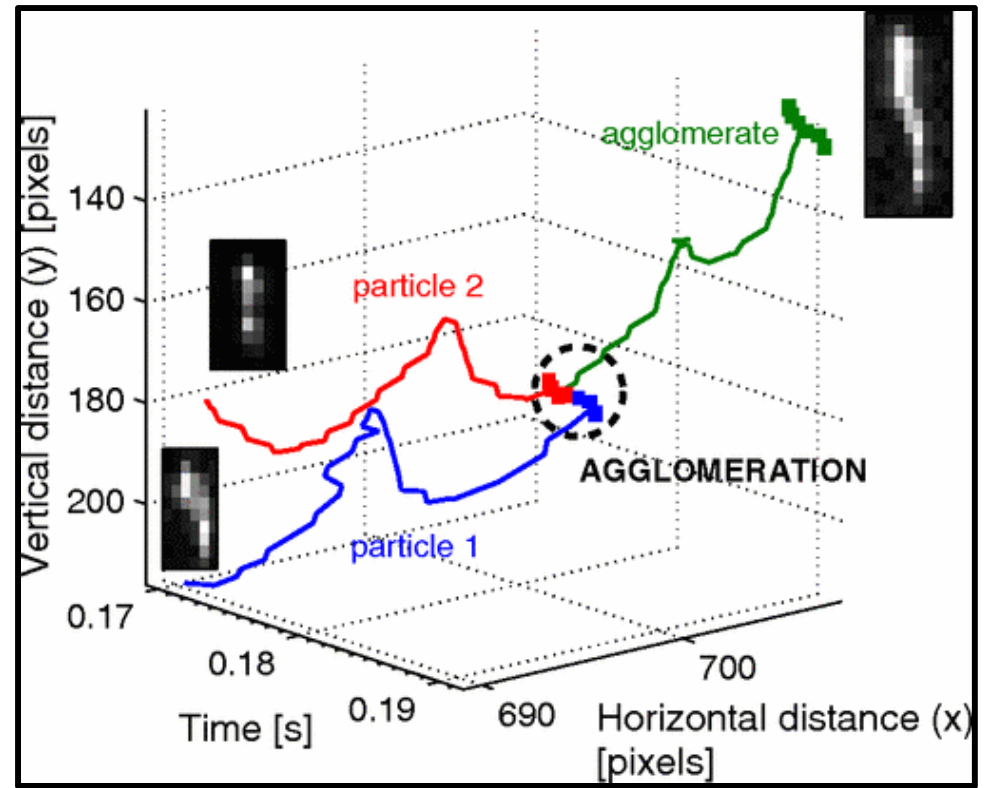

- A DA shock could also trigger agglomeration.

# Final Remarks

- Discoveries of waves in dusty plasmas -Mamun and Shukla (Journal of Plasma Physics, 2010):
- *Our Universe is full of dust, i.e., dust is almost everywhere; there is no branch of space science where the physics of dust is not directly or indirectly involved. We cannot explain the physics of our Universe without the role of dust.*
- Some remaining challenges:
  - Treating dust of variable size, charge and mass
  - Waves in dusty plasmas with *magnetized dust*

# Dust structurization (XT)

- For discharge currents  $\sim 1-10$  mA, propagating DAWs are excited
- For currents  $> 15$  mA, the dust cloud spontaneously evolved into nested conical regions of high and low dust density that are *stationary and stable*
- This phenomena was observed with various types and sizes of dust and in argon and helium discharges
- Structure formation in dusty plasmas predicted by Tsytovich and Morfill in 1998 & 2000.

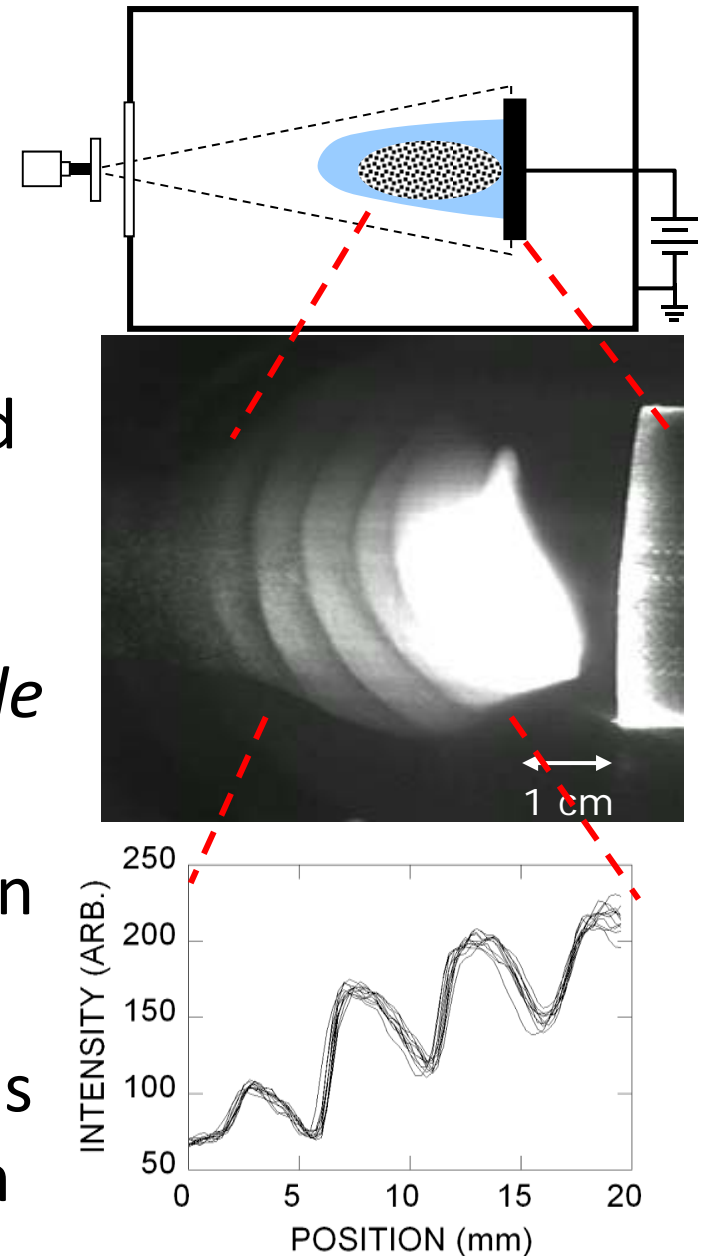

# Non-propagating DA waves (XT)

I. D'Angelo (PoP 5, 3155, 1998)

Included the effects of ionization and the ion drag force on DA waves and showed that a zero-frequency instability emerged.

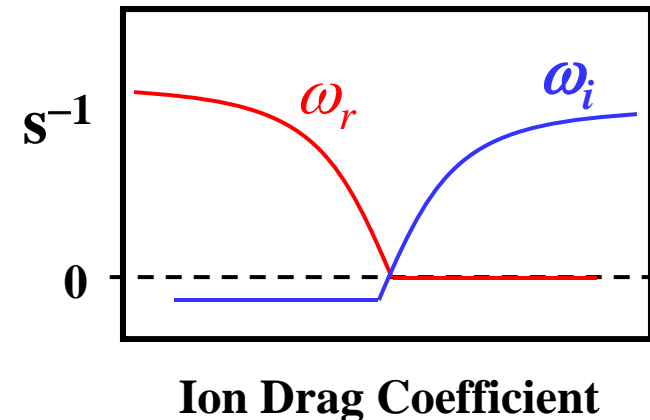

II. Khrapak et al., (PRL 102, 245004, 2009)

Included the effect of the polarization force on DA waves.

The polarization force on dust is present when there is a non-uniform plasma background, so that the screening distance is space-dependent, giving rise to a force

$$\vec{F}_{pol} = -\left(Q_d^2/2\right)\left(\nabla\lambda_D/\lambda_D^2\right)$$

The dispersion relation then becomes  $\omega / K = C_{da} \sqrt{1 - R}$  where R depends on the polarization force. When  $R > 1$ , a purely growing instability is found.

# Shock position, amplitude, thickness (XT)

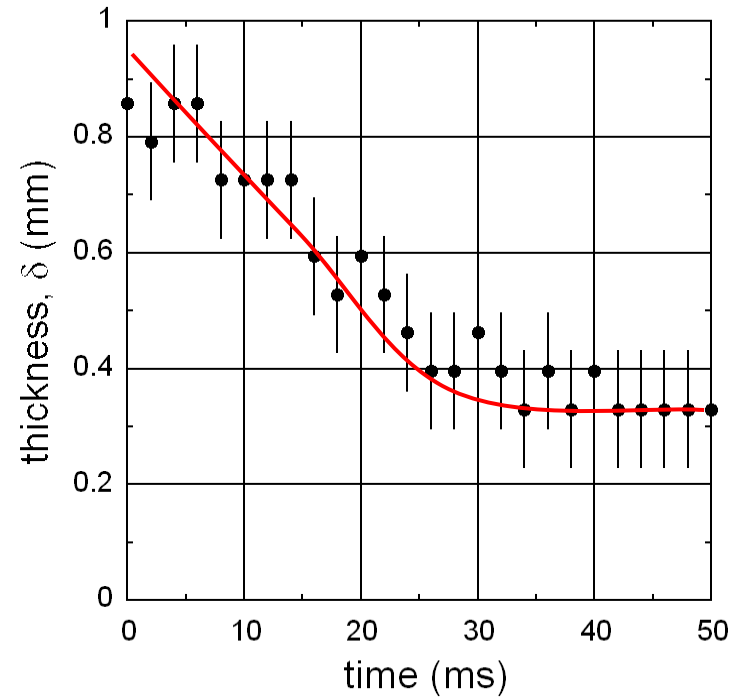
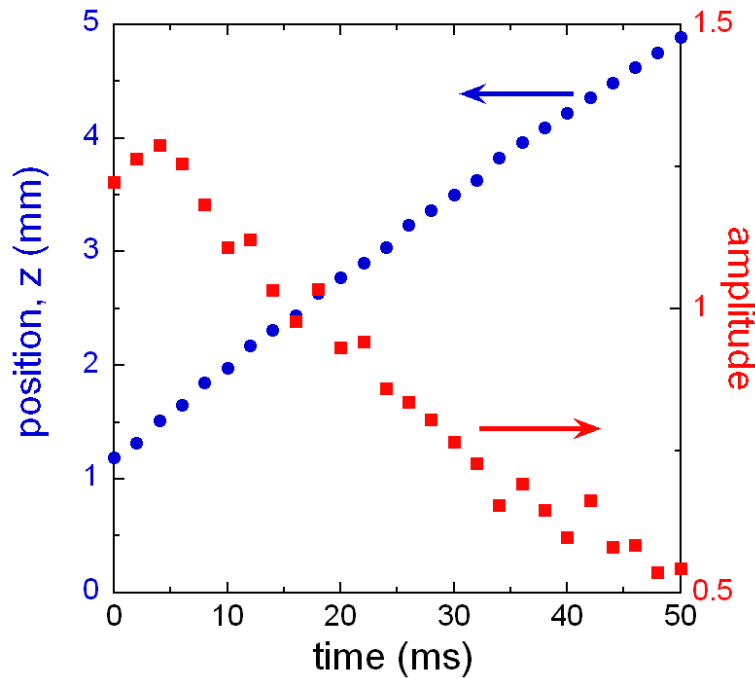

- The shock speed,  $V_S \approx 75$  mm/s, so that  $VS / Cda \gtrsim 1$ , where  $Cda$  is the dust acoustic speed, so that  $M \gtrsim 1$ .
- The shock steepens as it propagates, finally reaching a steady-state width  $\delta \gtrsim$  the interparticle spacing