

Parallel Performance and Optimization

Gregory G. Howes
Department of Physics and Astronomy
University of Iowa

Iowa High Performance Computing Summer School
University of Iowa
Iowa City, Iowa
1-3 June 2011



Thank you



Jerry Protheroe

Ben Rogers

Glenn Johnson

Mary Grabe

Greg Johnson

Amir Bozorgzadeh

Bill Whitson

Information Technology Services

Information Technology Services

Information Technology Services

Information Technology Services

Information Technology Services

Information Technology Services

Purdue University

and

National Science Foundation

Rosen Center for Advanced Computing, Purdue University

Great Lakes Consortium for Petascale Computing

Outline

- General Comments on Optimization
- Measures of Parallel Performance
- Debugging Parallel Programs
- Profiling and Optimization

General Comments on Optimization

- Always keep in mind the Rule of Thumb

Computation is FAST

Communication is SLOW

- If you can do extra work in an initialization step to reduce the work done in each timestep, it is generally well worth the effort
- Collect all of your communication at one point in your program timestep

Measures of Parallel Performance

- When you apply for time on a supercomputer, it is critical to provide quantitative data on the parallel performance of your application
- Algorithm vs. Parallel Scaling
 - **Algorithm scaling** measures the increased computational time as the size of computation is increased
 - **Parallel scaling** measures the decrease in wallclock time as more processors are used for the calculation
- Common measures of parallel scaling
 - **Strong Scaling**: Time for fixed problem size as number of processors is increased
 - **Weak Scaling**: Time for fixed computational work per processor as problem size is increased

Strong Scaling

- Measure time for fixed problem size as number of processors increases
- To get the best strong scaling, you want to find the **largest problem size** that will fit on one processor
- Eventually, all but embarrassingly parallel applications will lead to a turnover in the strong scaling plot:
 - As number of processors increases, computational work per processor decreases, and communication time typically increases.
 - This reduces the **granularity** (time for local computation vs. time for communication), and generally degrades parallel performance
- To get an impressive strong scaling curve, it will often take some experimentation to identify parameters that allow ideal performance over the widest range of processor number.
- Multi-core processors often lead to some complications in strong scaling behaviors due to bandwidth limitations of memory access.

Strong Scaling for HYDRO

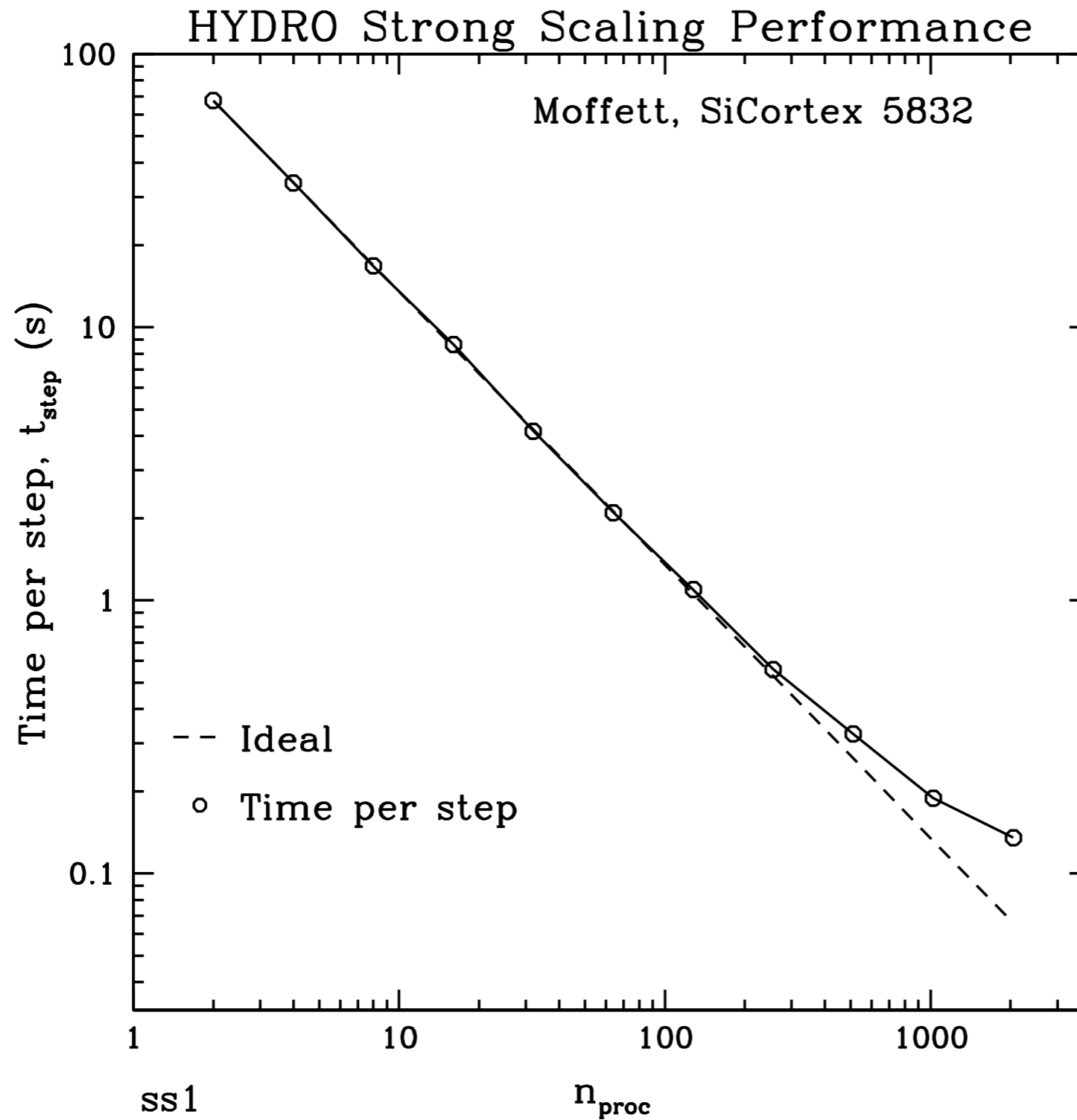

- Note: For ideal behavior, computational time is inversely proportional to the number of processors.

Strong Scaling for AstroGK

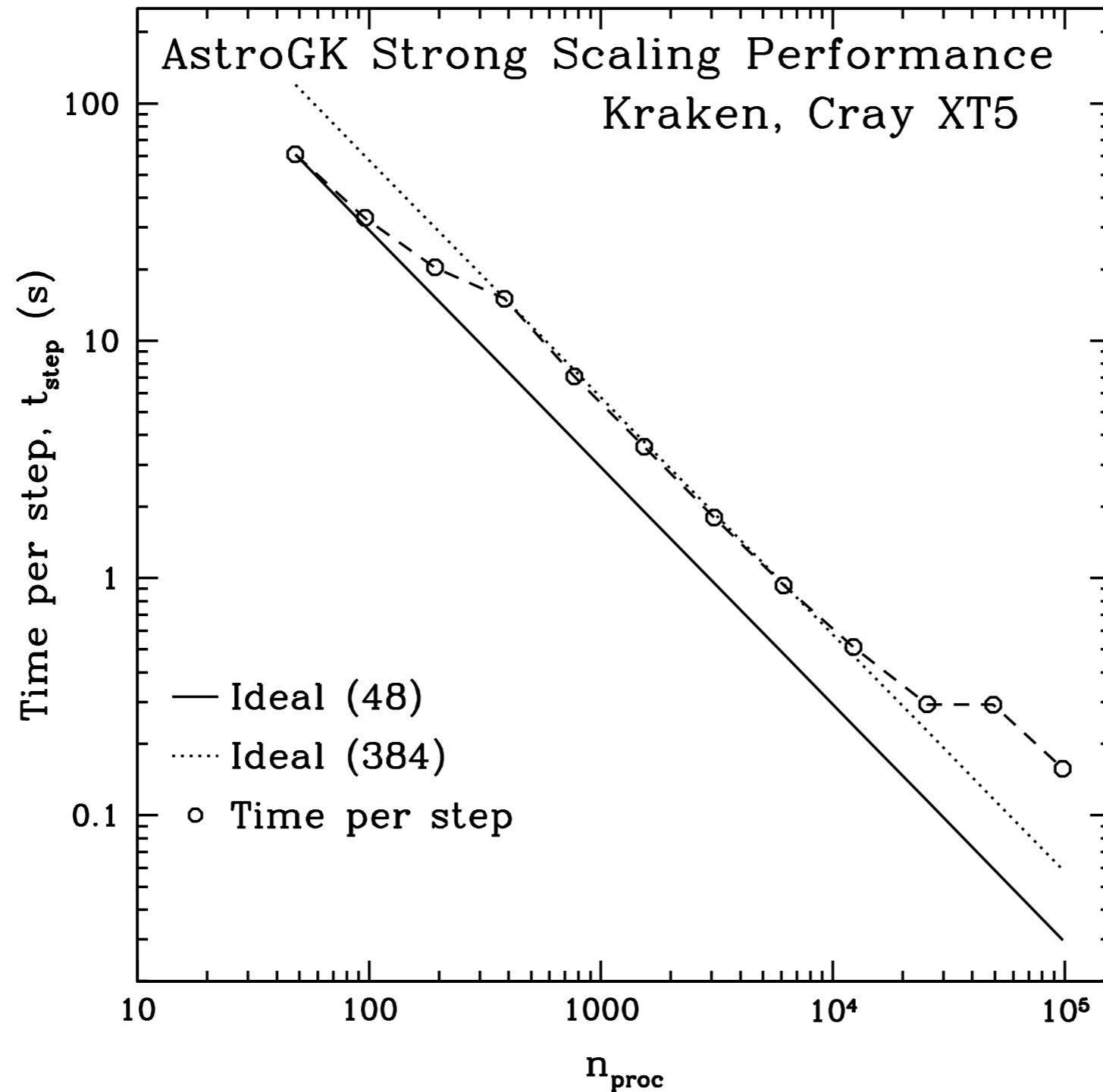

- Note: Kraken (Cray XT5) nodes have dual hex-core processors, so performance degrades as more cores/node are used due to memory bandwidth limitations

Weak Scaling

- Measure time for fixed computational work per processor as problem size is increased
- Again, you want to find the **largest problem size** that will fit on one processor
- It is usually easier to get a good weak scaling than a good strong scaling
 - Since computational work per processor is constant, granularity only decreases due to increased communication time
- Since the total problem size must increase, one has to choose how to increase it.
 - Ex: In **HYDRO**, you can increase either n_x or n_y
 - Often weak scaling performance will depend on which choice you make
- Again, some exploration of parameters may be necessary to yield the most impressive weak scaling curve

Weak Scaling for HYDRO

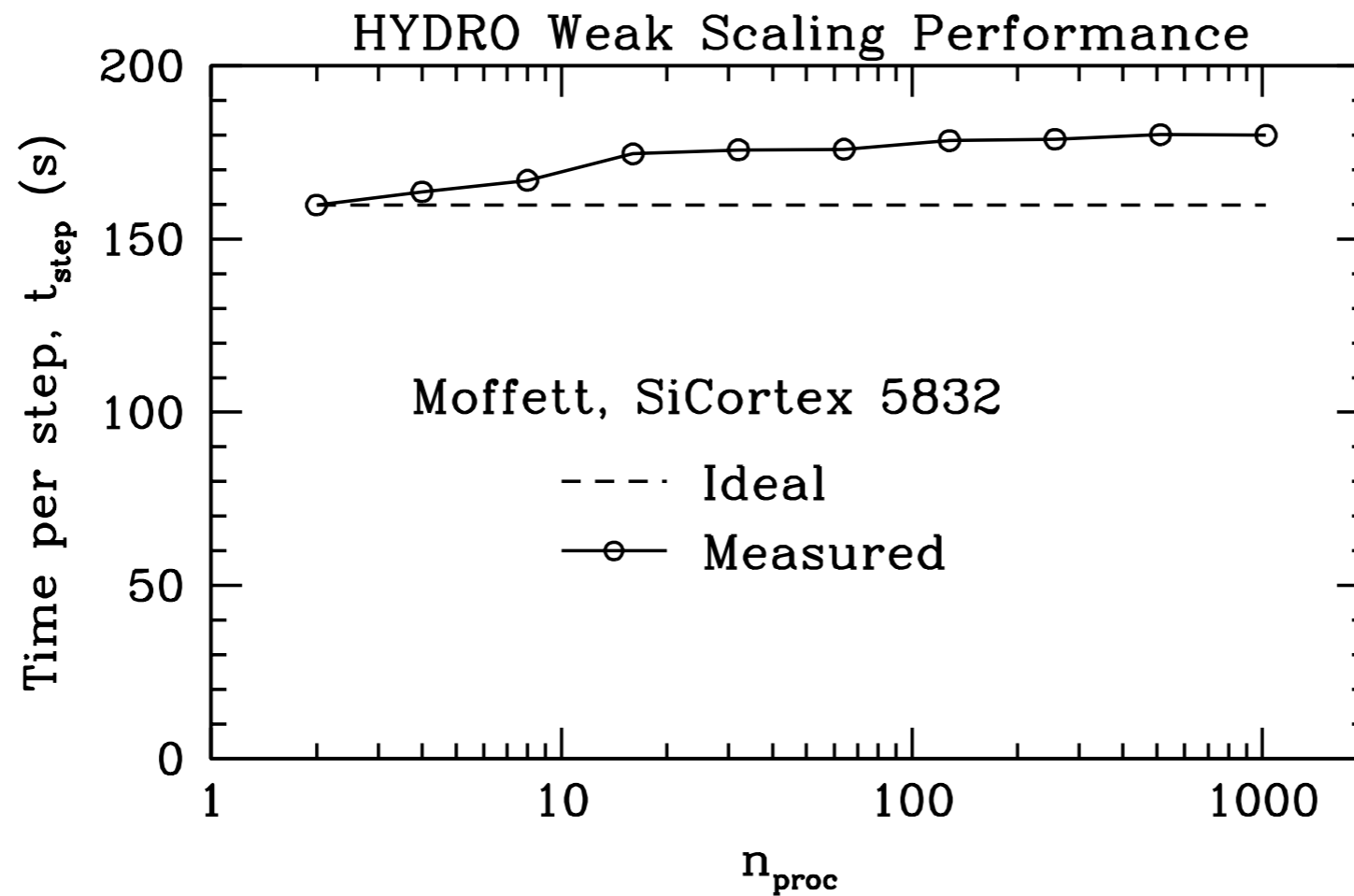

- Note: For ideal behavior, computational time should remain constant.

Weak Scaling for AstroGK

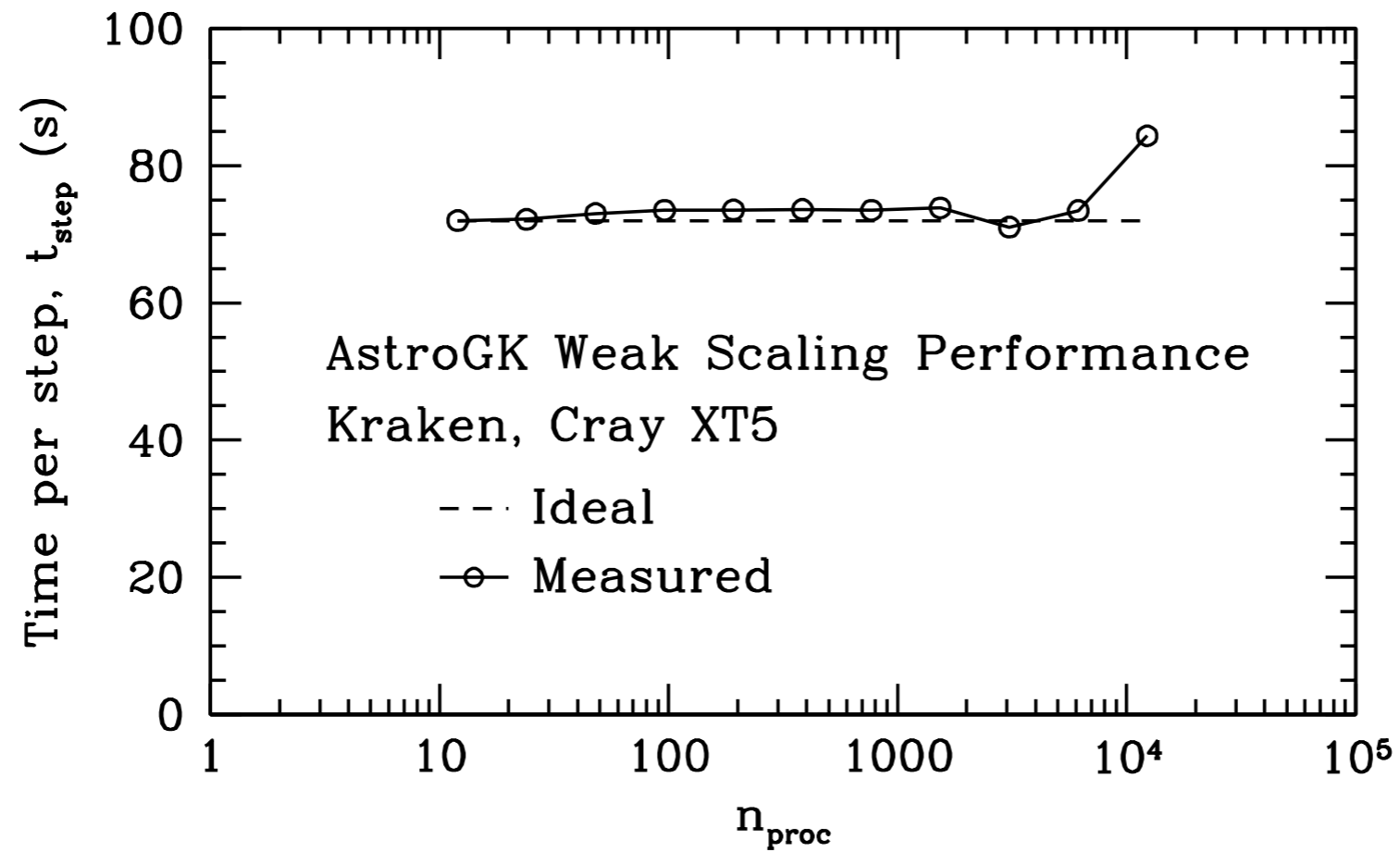

Speedup

- Another measure is the speedup, $S = \frac{\text{Time on 1 processor}}{\text{Time on } N \text{ processors}}$

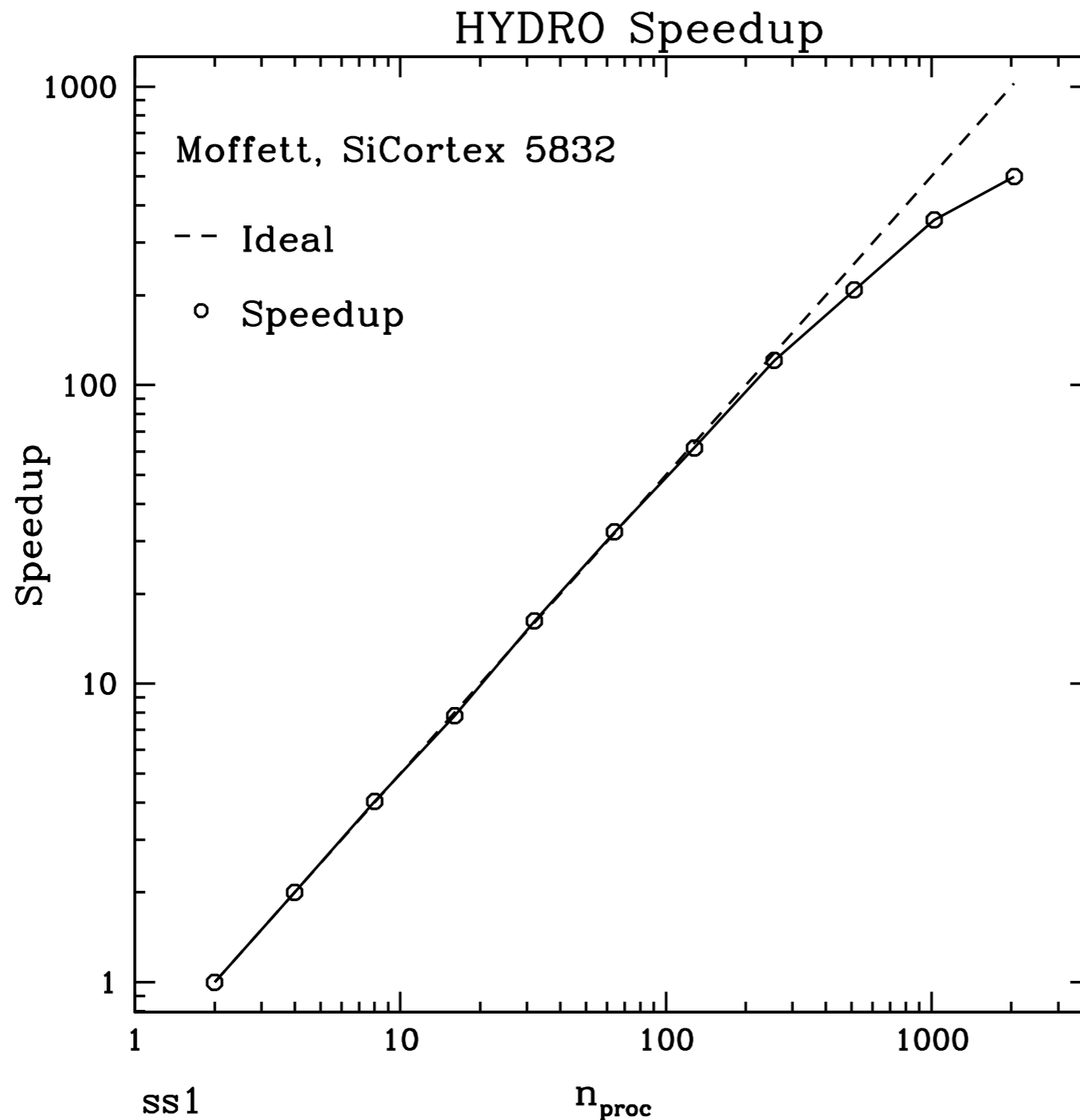

Linear vs. Logarithmic Scaling

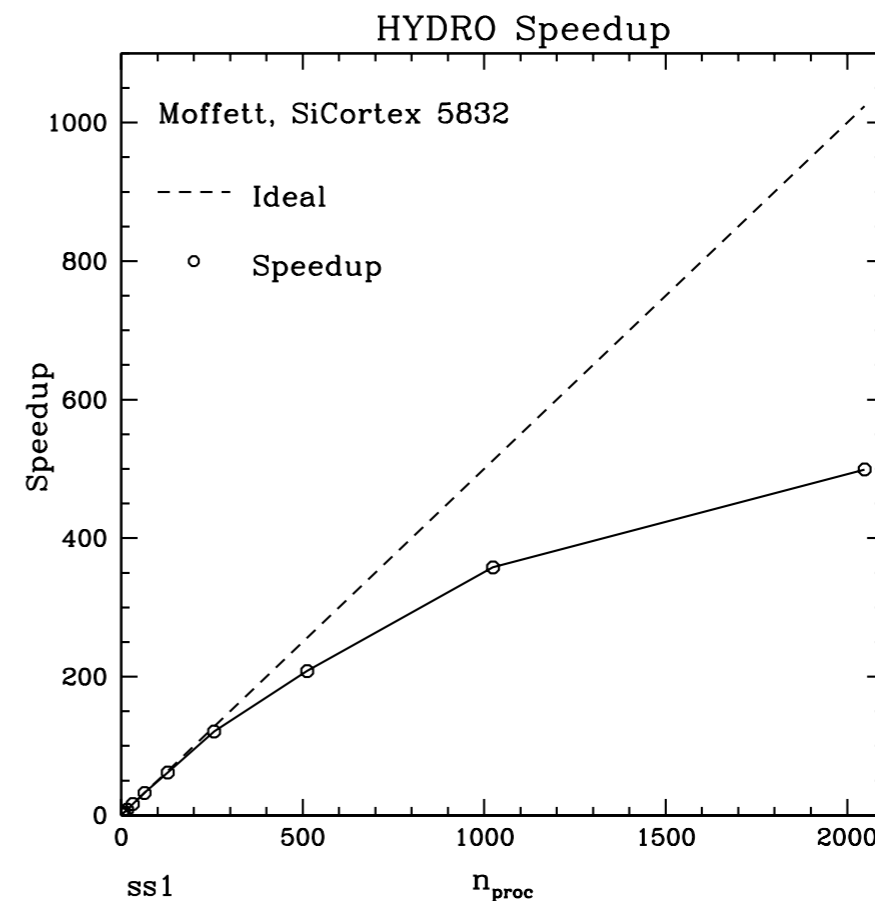
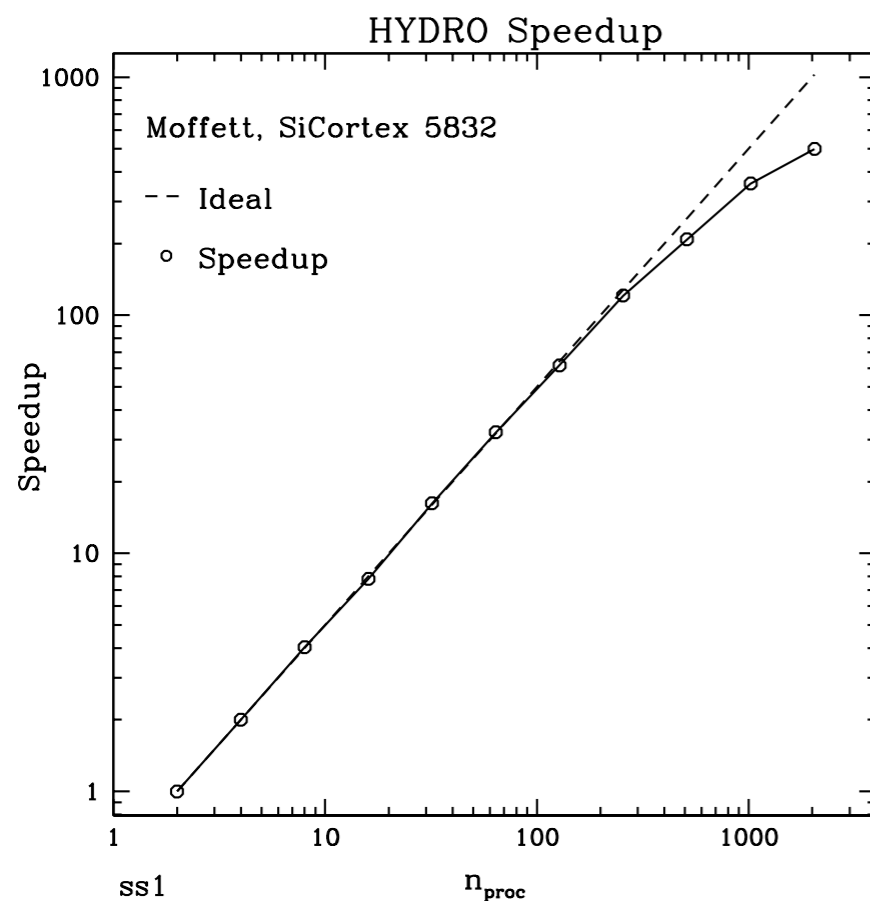
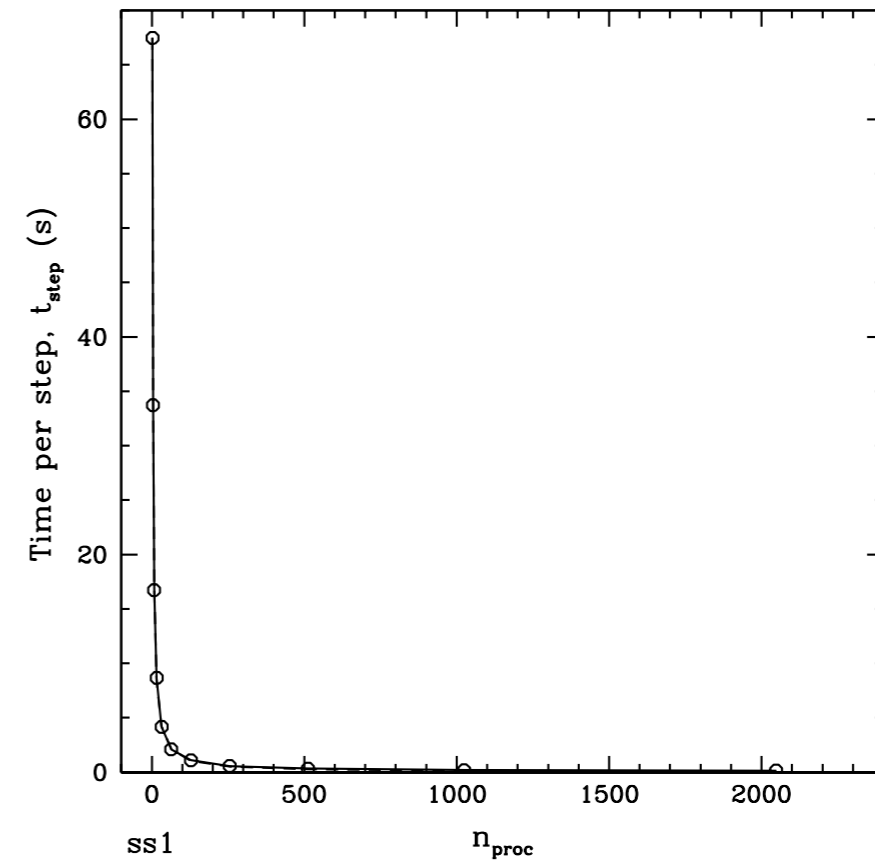
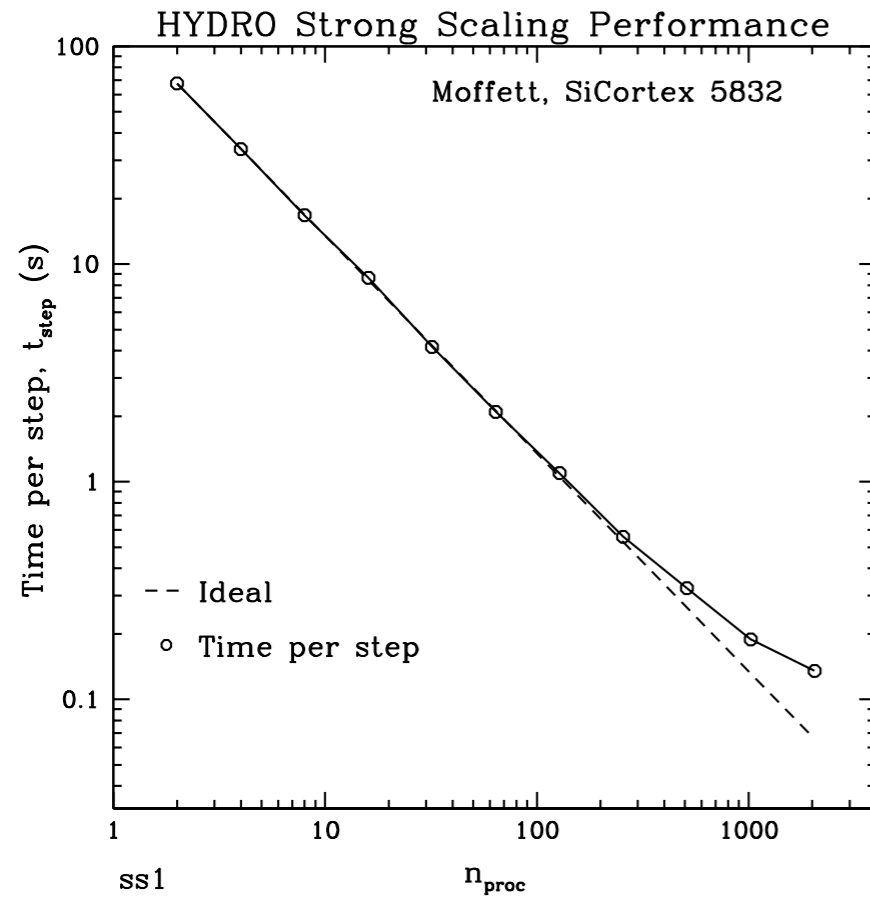

Additional Notes

- You need to choose what time you will use for the scaling tests:
 - Do you want to include or exclude initialization time?
- Be sure that your code does not write to the disk or the screen at any time during the scaling test (turn off output if possible), as this will lead to degraded performance.

Outline

- General Comments on Optimization
- Measures of Parallel Performance
- **Debugging Parallel Programs**
- Profiling and Optimization

Parallel Debuggers

- One can always debug by hand (inserting lines to write out output as the code progresses).
 - Generally the easiest approach
 - Time consuming
 - Difficult to debug problems particular to parallel codes, for example race conditions.
- In addition to serial debuggers to find errors in your source, such as gdb, a valuable tool for parallel programming is the use of parallel debuggers.
- Common parallel debuggers are **TotalView** and **DDT** (Distributed Debugging Tool)
- Parallel debuggers treat all tasks in an MPI job simultaneously, giving the user a view of the synchronization of different MPI tasks
 - This enables the identification of race conditions and other problems that are otherwise difficult to identify.
- Running out of memory is common problem in parallel applications

Outline

- General Comments on Optimization
- Measures of Parallel Performance
- Debugging Parallel Programs
- Optimization and Profiling

Code Optimization

General approaches to code optimization:

- **Automatic Optimization** at compile time (`mpif90 -O3`)
 - Level 3 optimization **may** produce incorrect results, so be careful
- Use **libraries of optimized routines** for common mathematical operations
 - BLAS and LAPACK for matrix computations
 - FFTW for Fast Fourier Transforms
 - Intel's Math Kernel Library (MKL) has routines optimized for particular architectures
- By hand, ensure **innermost loops** do no unnecessary computation
- **Profiling:**
 - Measuring the performance of the running code to generate a profile or trace file
 - Although it does introduce some overhead, it is a good way to measure code performance until typical running conditions

Profiling

Profiling: Measure performance by collecting statistics of a running code

- Two methods for triggering when to collect data:
 - Sampling
 - Triggered by timer interrupt or hardware counter overflow
 - Instrumentation
 - Based on events in the code (function calls, etc.)
 - Instrumentation code can be automatically generated or inserted by hand
- Two types of performance data:
 - Profile: Summation of events over time
 - Trace file: Sequence of events over time

Tools for Profiling

- You'll want to look at the system you are running on to see what profiling tools are installed
- For Moffett, optimization is covered in Chapter 5 of the Programming Guide
- Example Software tools for profiling on Moffett
 - **PAPI**: Measures general application performance
 - **MpiP**: Measure's MPI Performance
 - **HPCToolKit**: Event based sampling and profiling related to source code
 - **TAU** (Tuning and Analysis Utilities)
 - **Vampir** from ParaTools
 - **GPTL** (General Purpose Timing Library): Timers and counters
 - **IOex**: Measure I/O statistics
 - **Pfmon**: Performance monitor
 - **Oprofile**: Single-node statistical profiler
- Many of the tools above are available on many different platforms

SiCortex Architecture

- L1 and L2 Cache and Memory access

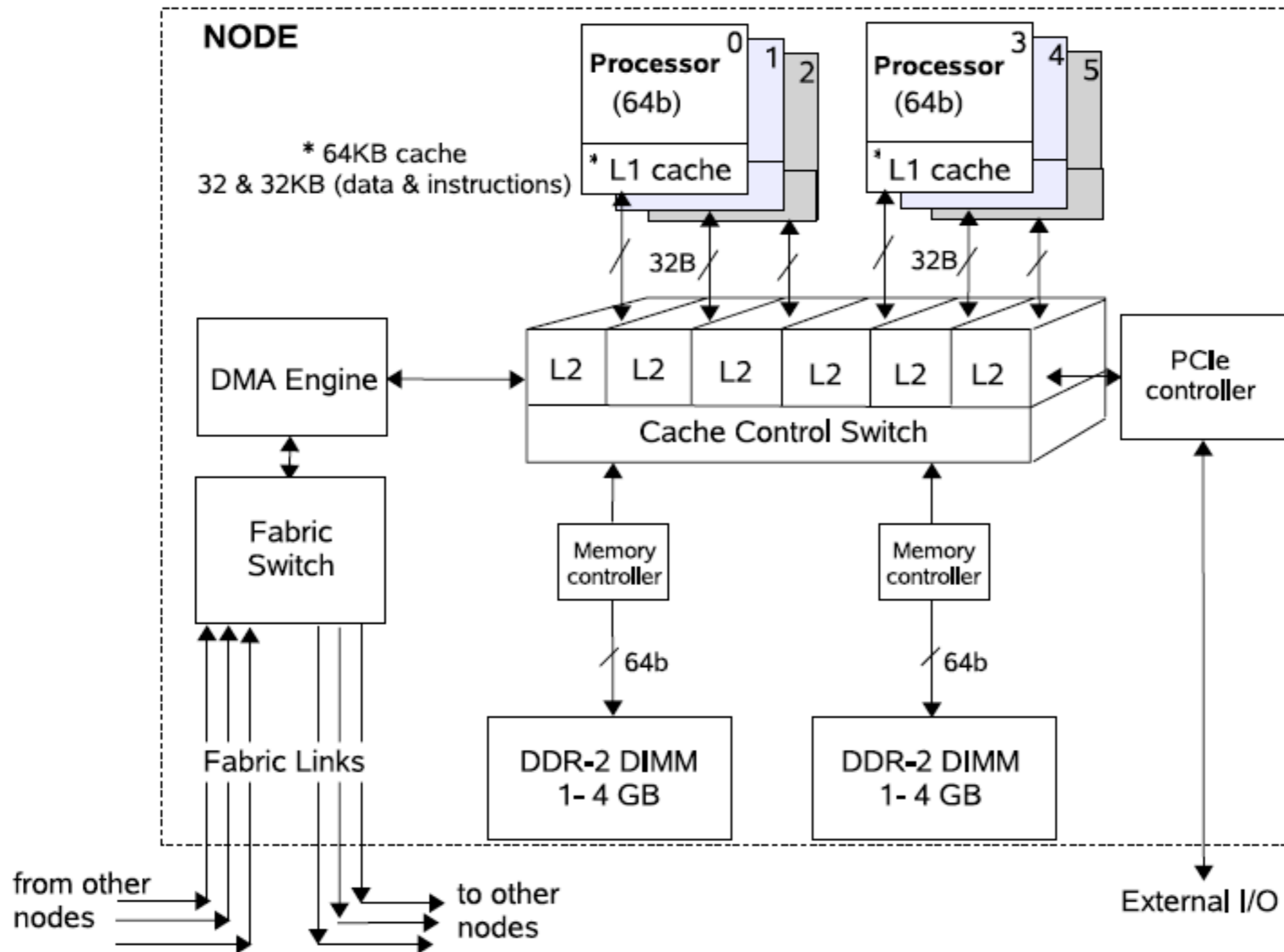

Figure 4. Architecture of the SiCortex node

Profiling Using PAPI and MpiP

- For the remainder of this talk, we do some profiling using the tools **PAPI** and **MpiP**
- You may follow along using the instructions on the handout.
- On the following pages, we will look at metrics derived by PAPI and the load balance and MPI statistics from MpiP.

PAPI Results on HYDRO

Total Computational Speed:

MFLOPS Aggregate (wallclock) 332.93

This is the total floating-point computational speed of your parallel computation

MFLOPS 24.16

Average floating-point computational speed per processor.

Floating-point vs. non-floating-point Instructions:

Non-FP Instructions % 76.87

FP Instructions % 23.13

Floating-point instructions to compute your answer:

FP Arith. Instructions % 7.79

FMA Instructions % 1.87

Computational Intensity and Cache Misses:

Flops per Load/Store 0.23

Flops per L1 D-cache Miss 3.70

PAPI Results on HYDRO

Memory Stall:

Total Est. Memory Stall %	36.32
---------------------------------	-------

Measured and Estimated Stall:

Total Measured Stall %	12.64
Total Underestimated Stall %	40.05
Total Overestimated Stall %	48.96

Ideal MFLOPS:

Ideal MFLOPS (max. dual)	62.14
Ideal MFLOPS (cur. dual)	64.67

Parallel Communication Overhead:

MPI cycles %	2.08
--------------------	------

PAPI Results on HYDRO

Memory Usage per Processor:

task_0.txt:Mem.	resident peak KB	62464
task_1.txt:Mem.	resident peak KB	61696
task_10.txt:Mem.	resident peak KB	61888
task_11.txt:Mem.	resident peak KB	61824
task_12.txt:Mem.	resident peak KB	61824
task_13.txt:Mem.	resident peak KB	59136
task_2.txt:Mem.	resident peak KB	61696
task_3.txt:Mem.	resident peak KB	61888
task_4.txt:Mem.	resident peak KB	61696
task_5.txt:Mem.	resident peak KB	61824
task_6.txt:Mem.	resident peak KB	61824
task_7.txt:Mem.	resident peak KB	61824
task_8.txt:Mem.	resident peak KB	61824
task_9.txt:Mem.	resident peak KB	61824

MpiP Results on HYDRO

MPI Time and Load Balance:

@--- MPI Time (seconds) -----

Task	AppTime	MPITime	MPI%
0	96.9	0.411	0.42
1	96.8	3.09	3.19
2	96.8	0.513	0.53
3	96.8	0.287	0.30
4	96.8	0.707	0.73
5	96.8	0.378	0.39
6	96.8	0.442	0.46
7	96.8	3.09	3.19
8	96.8	0.454	0.47
9	96.8	2.93	3.03
10	96.8	1.69	1.74
11	96.8	1.58	1.63
12	96.8	1.67	1.72
13	96.8	16.4	16.90